

MOTORIZED LIGHTBAND MKII

User Manual | 2000785L

spacesystems@rocketlabusa.com
rocketlabusa.com



Table of Contents

1.	REVISION HISTORY	4
2.	INTRODUCTION.....	5
3.	WHY CHOOSE MLB?.....	9
4.	MLB FLIGHT HISTORY.....	10
5.	MLB CAPABILITIES AND DIMENSIONS	11
6.	SELECTING AN MLB.....	12
6.1	LIGHTBAND SELECTION PROCESS FLOW CHART.....	12
6.2	STANDARD VS. CUSTOM MLB.....	13
6.3	LIGHTBAND SIZE DETERMINATION.....	14
6.3.1	Read this manual.....	14
6.3.2	Determine stiffness requirements.....	14
6.3.3	Determine strength requirements.....	14
6.3.4	Determine cyclic loading and fatigue requirements.....	14
6.3.5	Select an MLB diameter (bolt circle diameter).....	14
6.3.6	Determine separating energy.....	14
6.3.7	Complete virtual fit check and plan logistics.....	14
6.4	SPECIFYING AN MLB.....	15
6.4.1	Separation Switch quantity (SW).....	15
6.4.2	Separation Connector quantity (SC).....	15
6.4.3	Lightband Compression Tool quantity (LCT).....	15
6.4.4	End Use (FLT or EDU).....	15
6.4.5	Separating Energy (E.E).....	15
7.	MECHANICAL PROPERTIES.....	16
7.1	DIMENSIONS.....	16
7.2	TOLERANCE ON DIMENSIONS.....	17
7.3	MLB DESCRIPTION.....	18
7.4	HOW THE MLB WORKS.....	20
7.5	HOW THE MOTOR BRACKET ASSEMBLY WORKS.....	22
7.6	STIFFNESS.....	24
7.7	JOINT COMPLIANCE.....	24
7.8	DISCUSSION OF FEATURES ON ADJOINING STRUCTURES.....	25
7.9	FASTENERS TO ADJOINING STRUCTURES.....	28
7.10	LINE LOAD LIMITS.....	29
7.11	FLATNESS AND PARALLELISM.....	31
7.12	DAMPING RATIO.....	33
7.13	SOFTRIDE AND MLB.....	34
7.14	FATIGUE LIMITS.....	35
7.15	LIFECYCLE & REFURBISHMENT.....	35
7.16	ALIGNMENT.....	36
7.17	MATERIALS AND SURFACE TREATMENTS.....	36
7.18	PART MARKING.....	38
7.19	SUBSYSTEM MASSES.....	38
7.20	COMPONENT SPRING PARAMETERS.....	39
7.21	ROTATION RATES.....	40
7.22	SEPARATION VELOCITY, AND SEPARATION SPRINGS.....	41
8.	ELECTRICAL PROPERTIES.....	44
8.1	SCHEMATICS.....	44
8.2	THE MOTOR BRACKET ASSEMBLY.....	45
8.3	WIRING HARNESS DESIGN.....	46
8.4	SEPARATION ELECTRICAL CONNECTORS.....	47
8.5	SEPARATION SWITCHES.....	48
8.6	OPERATION ELECTRICAL PARAMETERS.....	49
8.7	SEPARATION PARAMETER VARIATION.....	50
8.8	SHORTED MOTORS.....	51
8.9	BACK EMF OF THE MOTORS.....	51
8.10	ELECTRICAL RESISTANCE.....	52
8.11	SURFACE CHARGING.....	52
8.12	RADIATION SENSITIVITY.....	52
8.13	STATIC SENSITIVITY.....	52
9.	THERMAL PROPERTIES.....	53
9.1	VALUE OF MOTORS IN EXTREME THERMAL ENVIRONMENTS.....	53
9.2	SURVIVAL AND OPERATING LIMITS.....	53
9.3	ABSORPTIVITY AND EMISSIVITY.....	53
9.4	THERMAL RESISTANCE.....	54
9.5	NOMINAL THERMAL RESPONSE.....	54
9.6	THERMAL GRADIENTS AND TRANSIENTS.....	54

10.	SHOCK PROPERTIES	55
10.1	MAXIMUM SHOCK GENERATED BY MLB.....	55
11.	RELIABILITY	57
12.	FAILURE MODES AND EFFECTS ANALYSIS (FMEA).....	58
13.	CLEANLINESS & HANDLING.....	59
13.1	CUSTOMER CLEANLINESS AND HANDLING REQUIREMENTS	59
13.2	CLEANLINESS AND HANDLING AT PSC.....	59
13.3	CLEANLINESS PRECAUTIONS	59
13.4	PART MARKINGS	59
14.	STORAGE REQUIREMENTS.....	60
15.	MLB OPERATION & INTEGRATION	61
15.1	ACCESS TO FASTENERS.....	61
15.2	VERTICAL AND HORIZONTAL INTEGRATION TO ADJOINING VEHICLES	62
15.3	LIGHTBAND COMPRESSION TOOLS	64
15.3.1	Vertical Integration	64
15.3.2	Horizontal Integration	64
16.	ACCEPTANCE TESTING.....	65
16.1	STANDARD ACCEPTANCE TESTS	65
16.1.1	Random Vibration Test.....	65
16.1.2	Thermal-Vacuum Test	67
16.2	CUSTOM ACCEPTANCE TESTS	68
16.2.1	Separation Reliability Test.....	68
16.2.2	Strength Test.....	73
17.	PURCHASING, DELIVERABLES, & SCHEDULE	75
17.1	PURCHASING AN MLB	75
17.2	STANDARD DELIVERY SCHEDULE.....	75
17.3	CUSTOM MLB SCHEDULE	75
17.4	MLB DELIVERABLES	75
17.5	MLB STEP FILES.....	75
17.6	ASSEMBLY DRAWINGS	76
17.7	MLB FINITE ELEMENT MODELS.....	76
18.	MANUFACTURING PROCESS	77
19.	QUALIFICATION TESTING.....	78
19.1	RANDOM VIBRATION QUALIFICATION TEST.....	78
19.2	THERMAL VACUUM QUALIFICATION TEST.....	79
19.3	STRENGTH QUALIFICATION TEST	79
19.4	SHOCK QUALIFICATION TEST.....	81
20.	MLB INSPECTION	82
21.	MLB TESTING AND PROCEDURES PERFORMED BY CUSTOMER	83
22.	GROUND SUPPORT EQUIPMENT (GSE)	84
23.	MLB TRAINING.....	86
24.	PACKING, SHIPPING AND UNPACKING METHODS	87
25.	REFERENCES	88
26.	WARRANTY.....	88
27.	ACKNOWLEDGEMENTS.....	88
28.	GLOSSARY.....	89

1. Revision History

Rev.	Issued	Written By	Released By	Change Description
-	14Sep2007	WH	MW	Initial release
A to G	2May2008 to 24Jul2018	varies	varies	For document simplicity previous revision change details are on file.
H	07Jun2022	ML	RH	<ul style="list-style-type: none"> • Updated cover page with updated logo and graphic • Typo fixes and grammatical changes throughout document. • Removed references to obsolete document numbers throughout document • Updated section, figure, table references • Table 5-1: updated emissivity and absorptivity values for accuracy, moved rotation rates to Section 16.2.1 • Moved "Selecting a Lightband" process to Section 6 • Section 6.2: updated standard and custom requirements process to current state, moved Separation reliability test to custom • Section 6.4: updated accessory description • Figure 7-1: added mtg hole position tolerance • Section 7.8: added warning regarding excessive roll flexibility • Section 7.9: added mtg hole dia and position tolerances • Section 7.14: added source of fatigue limits and derating guidance. • Table 7-8: updated Upper Hinge Link (4) plating option • Table 7-10: removed tolerance on stored spring energy • Section 8.7: added more information and significance of Figure 8-8 results • Section 15.3.1: updated vertical integration LCT quantity equation for accuracy • Section 16.1.2: removed details for to match current state • Section 16.2: moved Separation Reliability to custom acceptance test, added details about previous results • Section 16.2.2: deleted criteria for performing test • Section 16.2: removed shock test from custom acceptance testing. • Section 17: updated payment milestones and typical lead times to match current state • Section 23: updated details to match current state • Section 25: removed obsolete procedures and documents
I	N/A	N/A	N/A	• Revision skipped for alphanumeric clarity
J	03May2023	RJB	MDH	<ul style="list-style-type: none"> • Updated cover page • Section 6: Added clarification for 1x Sep. connector pair and 1x Sep. switch included with Standard MLB • Section 21: added mass-loaded customer vibration testing disclaimer
K	21Sep2023	HCH	CMF	<ul style="list-style-type: none"> • Table 5-1: Revised survival and operating temperatures to match standard qualification test levels, with justifying note. • Table 5-1: Revised nominal separation signal to increase margin, with justifying note. • Table 5-1: Added reference to 2000781 warning on motor simultaneity. • Section 7.5: Updated motor pinion attachment description. • Table 7-8: Updated materials to reflect component changes. • Section 8.2: Clarified wording • Section 9.2: Clarified definition of thermal limits • Section 11: Updated wording to reflect current MLB production rates. • Section 12: Clarified wording • Figure 19-1: Updated Qualification Vibration Testing datasheet • Figure 19-2 Updated Qualification Thermal Vacuum Testing datasheet • Figure 19-5: Updated Qualification Shock Testing datasheet.
L	08Jan2024	HCH	CMF	<ul style="list-style-type: none"> • Deleted outdated "Maximum Shock Applied to MLB" section • Section 13.4: Added

2. Introduction

The MLB is a space vehicle separation system. It is used to separate space vehicles from launch vehicles and to separate elements of launch vehicles. The MLB is offered in a range of sizes from 8.000 to 38.810 inch bolt circle diameter.

The content of this user manual is based on the experience of providing more than 200 separation systems to commercial, government and university customers, both domestic and international, whom launch payloads on a broad range of orbital and sub-orbital launch vehicles. The MLB is a patented, Commercial Off-The-Shelf (COTS) technology. It is made with materials and methods consistent with high-reliability and Class-A space flight hardware.

This is the user manual for the Mark II Motorized MLB only. **The MkII can be uniquely identified from other MLBs. On the MkII, the motors are on the outer diameter of the unit.**

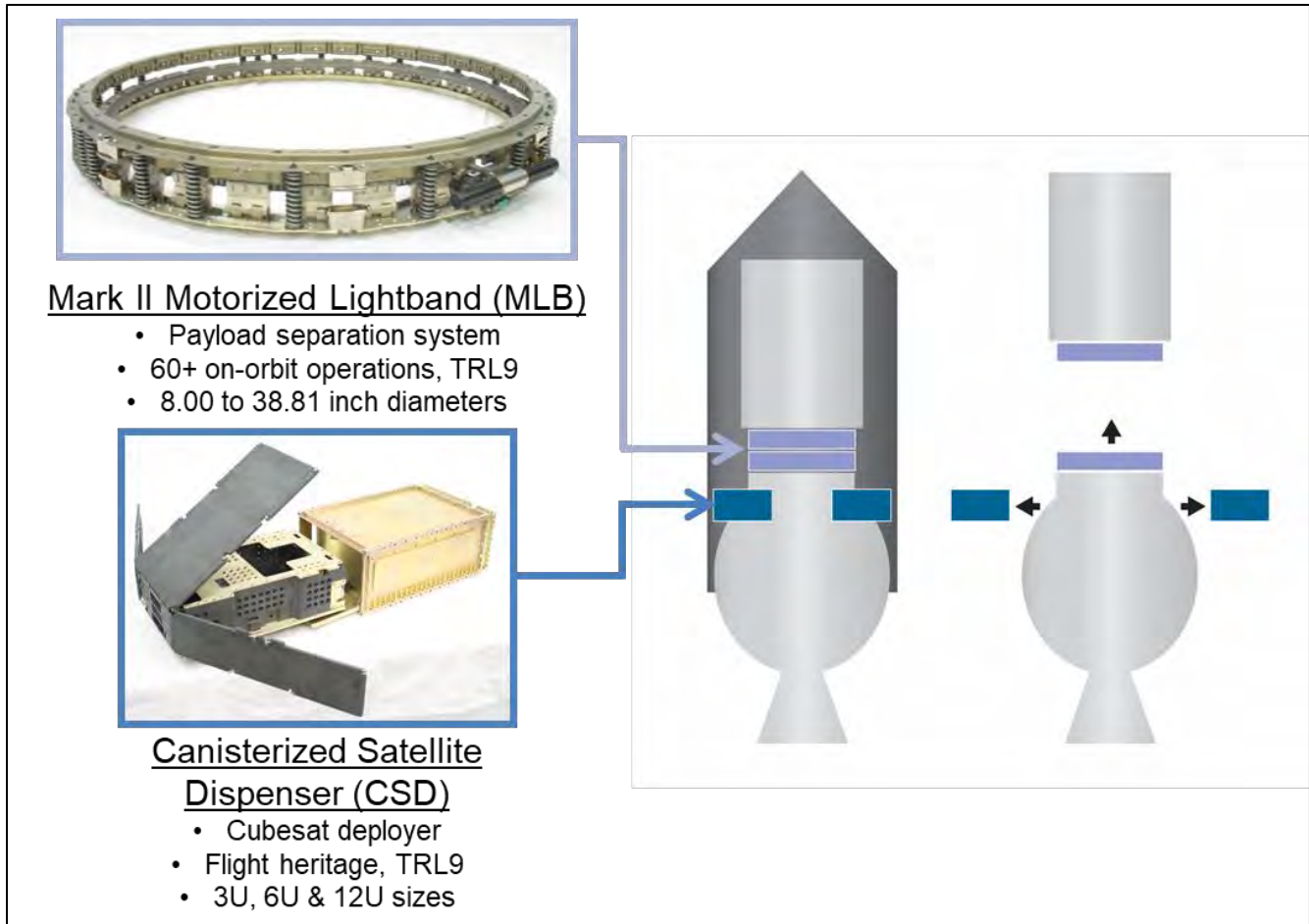

Figure 2-1: MLB separates Space Vehicles from Launch Vehicles. CSD is another PSC product for smaller space vehicles.



Figure 2-2: Two of NASA's lunar GRAIL satellites separate from a Delta II in 2011 using 2X MLB19.848

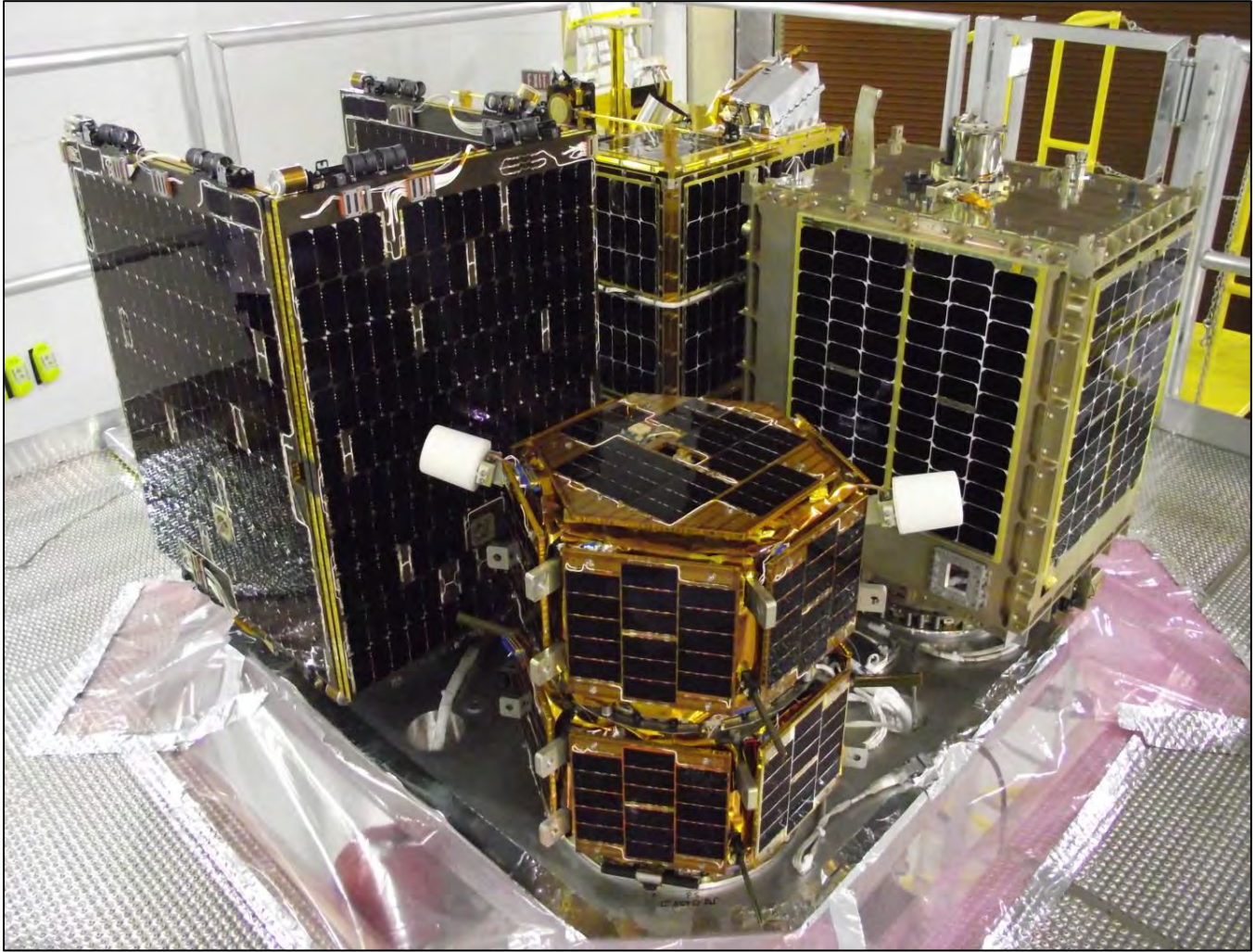

Figure 2-3: Four MkII and one MkI MLBs used to separate five spacecraft on STP S-26 in November 2010

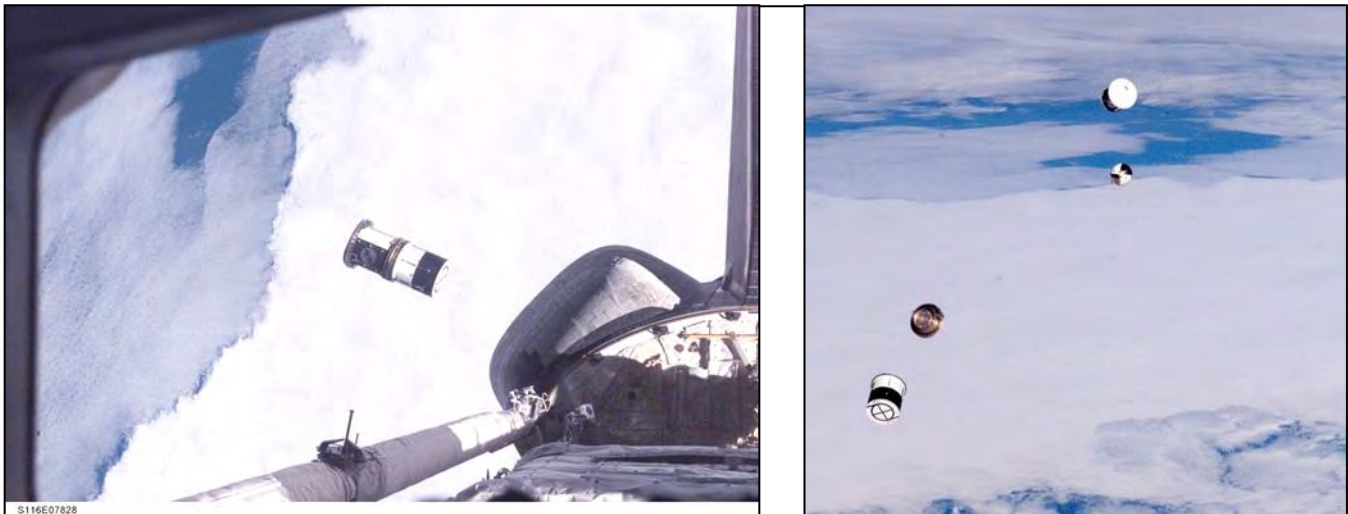

Figure 2-4: ANDE-1 Separation from Shuttle (STS-116). Three MkI MLBs were used.

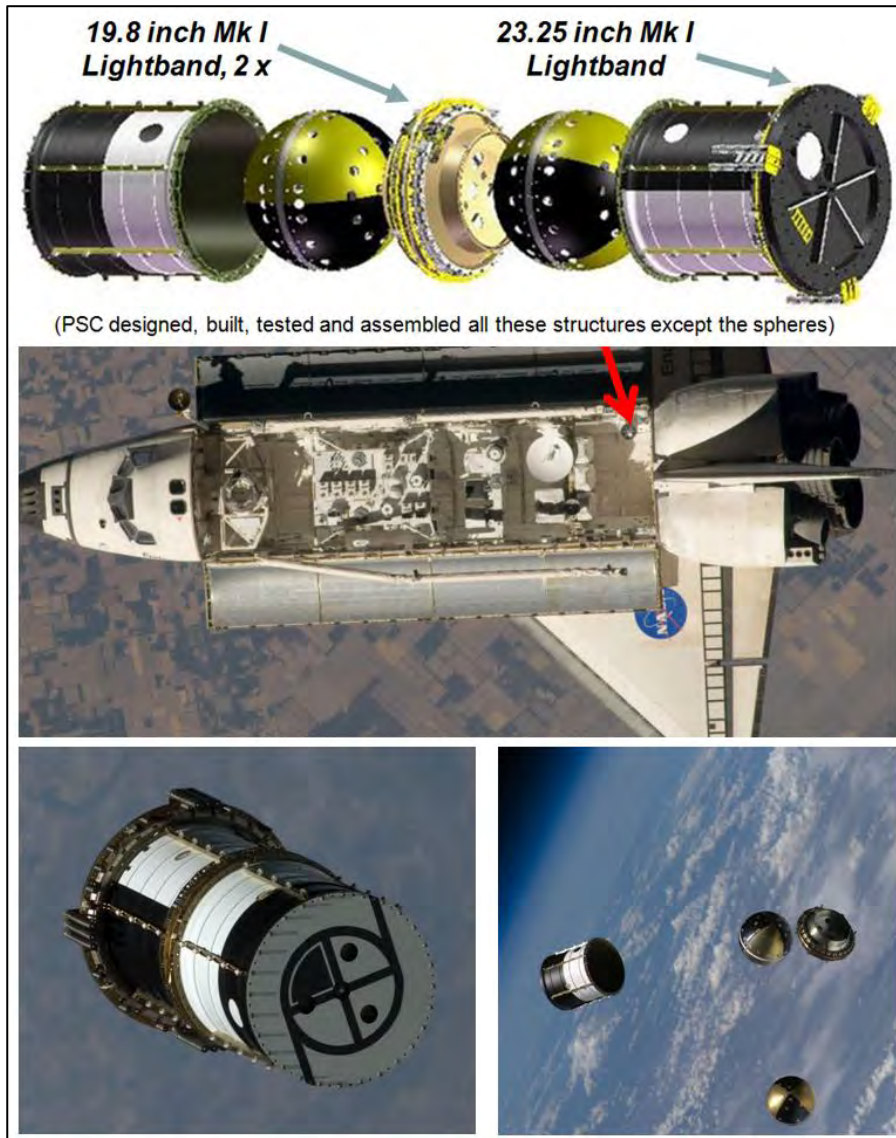

Figure 2-5: CAPE-ICU II and ANDE-2 on STS 127, July 2009

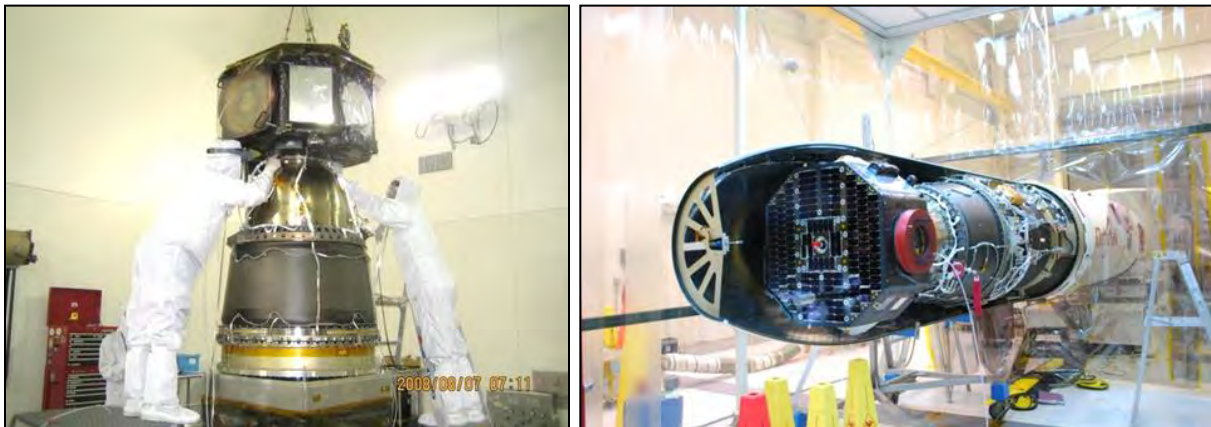

Figure 2-6: Three MkII MLBs (38.8, 31.6 and 15.0 inch diameter) are used on the IBEX Program.



Figure 2-7: MLBs on ESPA (STP-1) on an Atlas V



Figure 2-8: Two MLBs installed on a lunar payload prior to launch¹

¹ Source: http://www.nasa.gov/sites/default/files/ladee_encapsulation.jpg

3. Why Choose MLB?

The MLB has many advantages over competing products:

1. **Flight heritage.** Hundreds of successful on-orbit separations.
2. **Technology Readiness Level 9 rating.** TRL 9 is the maximum attainable level of this measure which is used by US Government agencies to assess the maturity of evolving technologies.
3. **Test-verified.** Each MLB goes through environmental testing before delivery to prove separation capability on orbit.
4. **Minimal reset time.** MLB can be operated by customers and reset in minutes. Competing products require hours to reset.
5. **Lightweight.** The MLB is about one third of the weight of a typical clamp band.
6. **Low-height.** About one half of the height of a typical clamp band.
7. **Non-pyrotechnic.** The MLB generates no debris upon or after separation.
8. **Low-shock.** The MLB generates very low shock relative to other separation systems.
9. **Low tip-off.** The rotation rates generated during separation are test verified on a unique 5 degree of freedom air bearing fixture.
10. **All-inclusive product.** The MLB is delivered with Separation Springs, Switches and Connectors included within its assembly and does not require additional brackets.
11. **No consumables.** Motor-driven, eliminating the need for refurbishment or consumable initiators.
12. **Pyro-pulse compatible.** The MLB can be separated via a pyro-pulse signal.
13. **Ideal for ISS.** The MLB can be configured so as not to require auxiliary mechanical inhibits. This is useful for unique mission redundancy requirements such as those of International Space Station payloads.

4. MLB Flight History

No MLB has ever failed to separate on orbit. To date, the MLB has operated successfully in flight more than 100 times. See the flight heritage section of PSC's website for the most up-to-date list (www.planetarysystemscorp.com).

The MLB has been used on the following launch vehicles:

- Antares
- Athena
- Atlas V
- Delta II
- Delta IV
- Delta IV Heavy
- Electron
- Epsilon
- Falcon 1
- Falcon 9
- Falcon 9 Heavy
- International Space Station (ISS)
- Minotaur I
- Minotaur IV
- Minotaur V
- Minotaur C
- Pegasus XL
- Polar Satellite Launch Vehicle (PSLV)
- Soyuz
- Space Shuttle
- Super Strypi
- Vega



Figure 4-1: An MLB installed on the TacSat-2 mission

5. MLB Capabilities and Dimensions

Parameter		Doc. Section	Value											
Size	Bolt Circle Diameter ± 0.01 [in]		-	8.000	11.732	13.000	15.000	18.250	19.848	23.250	24.000	31.600	38.810	
	Number of Fasteners		-	12	18	20	24	28	28	32	36	48	60	
PN	PSC Assembly Number		-	4000515	4000841	4000894	4000389	4000938	4000447	4000436	4000837	4000713	4000409	
Dimensions	Stay-Out Dimensions [in] (1)	A	7.1	10.04	13.76	15.02	17.02	20.27	21.87	25.42	26.17	33.76	40.97	
		B	7.1	7.00	10.83	12.11	14.14	17.41	19.00	22.41	23.18	30.80	38.03	
		C	7.1	5.93	9.60	10.58	12.41	15.48	17.07	20.28	20.95	28.17	35.30	
		D	7.1	0.56	2.67	3.36	4.43	6.12	6.93	8.67	9.06	12.92	16.55	
		E	7.1	5.39	7.50	8.19	9.25	10.94	11.76	13.50	13.89	17.74	21.38	
		F (±0.01)	7.1	1.03	1.03	1.03	1.03	1.03	1.03	1.03	1.05	1.05	1.15	1.15
Mass Properties	Mass ± 5% [lb _m] (2)	Upper Assembly	7.19	0.78	1.15	1.27	1.47	1.83	1.99	2.36	2.42	3.61	4.51	
		Lower Assembly	7.19	2.50	3.47	3.76	4.32	5.05	5.25	6.08	6.53	8.77	10.57	
		Total	7.19	3.28	4.62	5.03	5.79	6.88	7.24	8.44	8.95	12.38	15.08	
	Center of Mass ± 0.1 [in] (2)	X _{LB}	-	1.09	1.07	1.07	1.07	1.07	1.07	1.07	1.07	1.07	1.07	
		Y _{LB}	-	1.11	1.08	1.06	1.04	1.12	1.14	1.14	1.10	0.98	0.95	
		Z _{LB}	-	0.00	0.00	0.00	0.00	0.00	0.00	0.00	0.00	0.00	0.00	
		X _{LB} , Upper Assembly	-	1.68	1.68	1.68	1.68	1.68	1.68	1.67	1.66	1.60	1.60	
		Y _{LB} , Upper Assembly	-	-0.08	-0.09	-0.09	-0.09	-0.10	-0.10	-0.10	-0.10	-0.12	-0.12	
		Z _{LB} , Upper Assembly	-	0.00	0.00	0.00	0.00	0.00	0.00	0.00	0.00	0.00	0.00	
	Inertia ± 10% [lb _m ·in ²] (2)	X _{LB} , Lower Assembly	-	0.88	0.85	0.85	0.86	0.85	0.84	0.84	0.84	0.86	0.85	
		Y _{LB} , Lower Assembly	-	1.19	1.44	1.41	1.37	1.51	1.58	1.60	1.52	1.44	1.39	
		Z _{LB} , Lower Assembly	-	0.00	0.00	0.00	0.00	0.00	0.00	0.00	0.00	0.00	0.00	
		I _{xx} (3)	-	52	156	207	317	559	697	1,121	1,267	3,052	5,622	
		I _{yy} (3)	-	22	67	91	140	250	312	508	578	1,424	2,648	
I _{zz} (3)		-	32	92	120	180	314	391	619	696	1,637	2,985		
Loading & Boundaries	Maxium Line Loads (4)	X _{LB} (Axial) [lb _f /bolt]	7.10	1,504										
		Y _{LB} or Z _{LB} (Shear) [lb _f /bolt]	7.14	619										
	Stiffness about X _{LB} ±25% [lb _f /in] (5)		7.6	1.80E+6	2.64E+6	2.93E+6	3.38E+6	4.11E+6	4.47E+6	5.23E+6	5.40E+6	7.11E+6	8.73E+6	
	Stiffness about Y _{LB} or Z _{LB} ±25% [in·lb _f /rad] (5)		7.6	1.40E+7	4.43E+7	6.02E+7	9.25E+7	1.67E+8	2.14E+8	3.44E+8	3.79E+8	8.65E+8	1.60E+9	
	Required flatness of adjoining structure if structure is "flexible" [in] (6)		7.8, 7.11	0.0028	0.0042	0.0046	0.0053	0.0065	0.0071	0.0083	0.0085	0.0112	0.0138	
	Required flatness of adjoining structure if structure is "stiff" [in] (6)		7.8, 7.11	0.0021	0.0031	0.0035	0.0040	0.0049	0.0053	0.0062	0.0064	0.0084	0.0103	
	Electrical	Nominal Separation Signal (12)		8.6	24 to 32 V for 1.0 s									
		Time to Initiate [s] (10 to 30 °C)		8.6	0.040 to 0.100									
		Simultaneity of Motor Power On and Off		8.6	See Section 4: Warnings in latest rev of 2000781 MkII MLB Operating Procedure									
	Thermal	Thermal Resistance [°C/W]		9.4	0.392	0.267	0.241	0.209	0.172	0.158	0.135	0.130	0.099	0.081
Non-Operational Survival Limits [°C] (11)		9.2	-47 to +118											
Allowable Operational Limits [°C] (11)		9.2	-36 to +99											
Solar Absorptivity (α) [-]		9.3	0.25 to 0.85											
Emissivity (ε) [-]		9.3	0.76 to 0.86											
Shock	Generated Shock		10.1	varies with size and adjoining structures										
Payload Separation	Nominal Separating Energy [J] (7)		7.22	3.4 to 5.1	5.1 to 10.1	5.1 to 11.8	5.1 to 13.5	5.1 to 16.9	5.1 to 16.9	5.1 to 18.6	5.1 to 20.3	5.1 to 20.3	6.8 to 20.3	
	Qty. of Separation Springs [-] (8)		7.22	4 to 6	6 to 12	6 to 14	6 to 16	6 to 20	6 to 20	6 to 22	6 to 24	6 to 24	8 to 24	
Accessories	Max Qty. of Lightband Comp. Tools [-] (9)		15.3	6	12	14	16	20	20	22	26	34	46	
	Max. Sep. Connector & Switch Qty. (sum) (10)		7.3	4	4	4	6	6	6	8	8	12	12	
Lifecycle	Usable Life Before Potential Refurb. [cycles]		7.15	60										
	Max. Storage Duration (Stowed) [year]		14	1										
	Max. Storage Duration (SFF) [year]		14	1										
	Max. Storage Duration (Deployed) [year]		14	3										

- (1) The customer-supplied wiring harness may exceed these dimensions.
- (2) Does not include Separation Springs or Accessories.
- (3) Measured about CM in stowed state.
- (4) Values listed are 80% of qualification loads.
- (5) Does not include compliance of the joint to the adjoining structure. Can be test-correlated to increase precision.
- (6) "Stiff" is a machined plate or honeycomb plate. "Flexible" is an adapter ring or isolation system.
- (7) Used to predict payload (satellite) separation velocity relative to final stage (launch vehicle). Total Separation Energy Tolerance is ±2.0 J.
- (8) Listed range is the nominal capability to inform customer. Actual qty. is chosen by PSC during test to meet Separating Energy requirement.
- (9) If high qty. of Springs and LCTs, LCTs may exceed outer stayout diameter, A, due to need to rotate them to fit.
- (10) For example, on an MLB15 there may be 4 Separation Switches and 2 Separation Connectors (4 + 2 = 6).
- (11) Survival Limits are the most extreme levels seen during qualification testing. Operational limits are 10°C less extreme than a unit was successfully operated at during qualification testing. Flight MLBs are acceptance tested per 16.1.2. MLBs have survived and operated under more extreme temperatures historically and during flight.
- (12) Motor switches open at time of initiation, so powering circuit for longer than the expected time to initiate is not detrimental and provides additional margin. This duration encompasses the measured worst-case initiation time of an MLB at -47°C with one motor shorted.

Table 5-1: MLB capabilities and dimensions

6. Selecting an MLB

There are many determinations that must be made when a customer is selecting an MLB to purchase. This section outlines the process and choices.

6.1 Lightband Selection Process Flow Chart

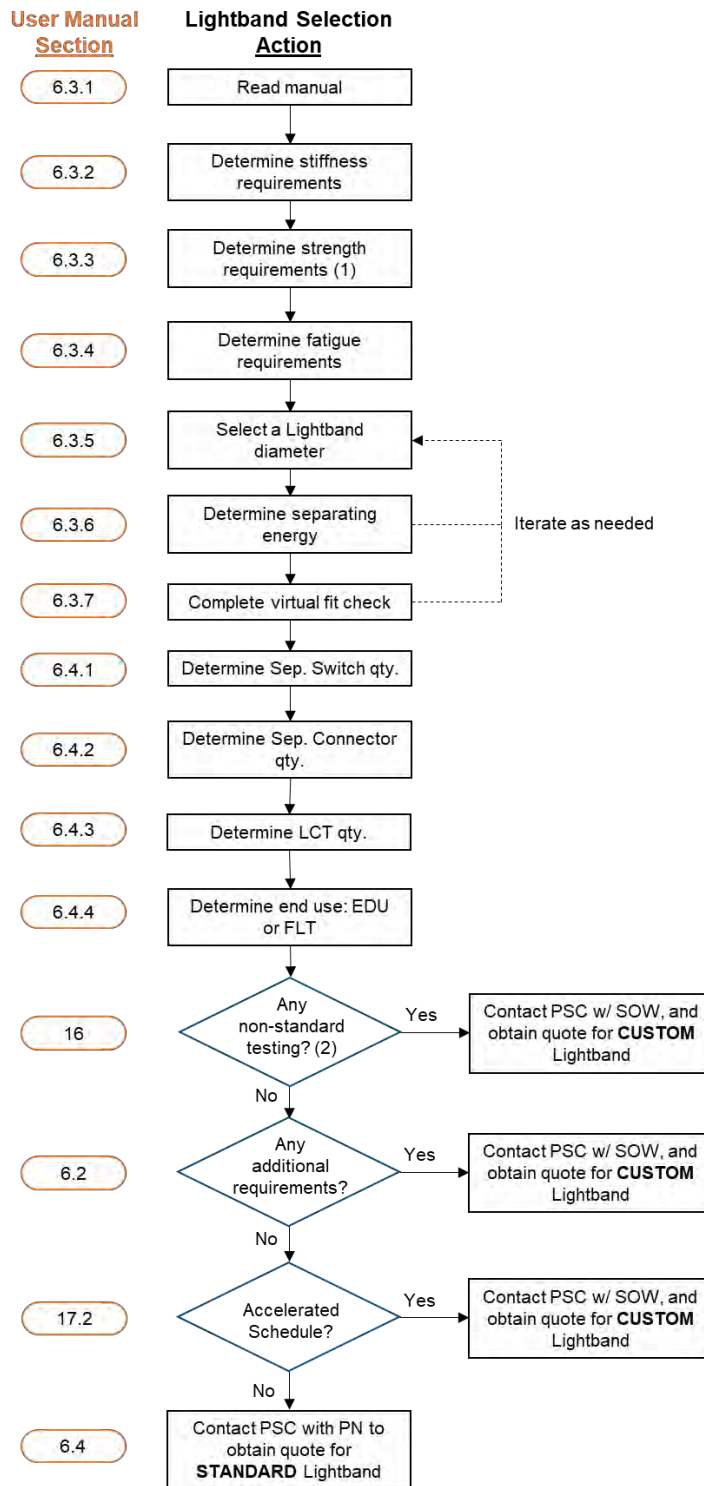

- 1) Also carefully review section 16.2.2 to determine if a strength test is required.
- 2) Non-standard includes
 - a) Any change to standard acceptance test requirements (16.1)
 - b) Or execution of a strength test or separation reliability test (16.2)
 - c) Or any test not specified in this user manual

Figure 6-1: MLB selection process flow chart

6.2 Standard vs. Custom MLB

Any MLB that deviates from requirements defined in this document (e.g. requires custom features, additional testing, different procedures, or different compliance documents) is considered a Custom MLB. Due to the extensive flight heritage of accessories, Standard FLT MLBs undergo Vibration and Thermal Vacuum testing with a default spring, separation connector, and separation switch configuration. Prospective users should be aware that the cost and schedule of Custom MLBs is often substantially greater than the Standard MLB presented in this document. See Figure 6-2 and Figure 6-3.

A common question is the rotation rate of the spacecraft after separation. PSC has performed hundreds of Separation Reliability tests of varying sizes and configurations with flight heritage aligning test results. The overwhelming results indicate that MLBs with standard testing will meet, or be very close to, the rotation rates specified in Table 16-2 in flight.

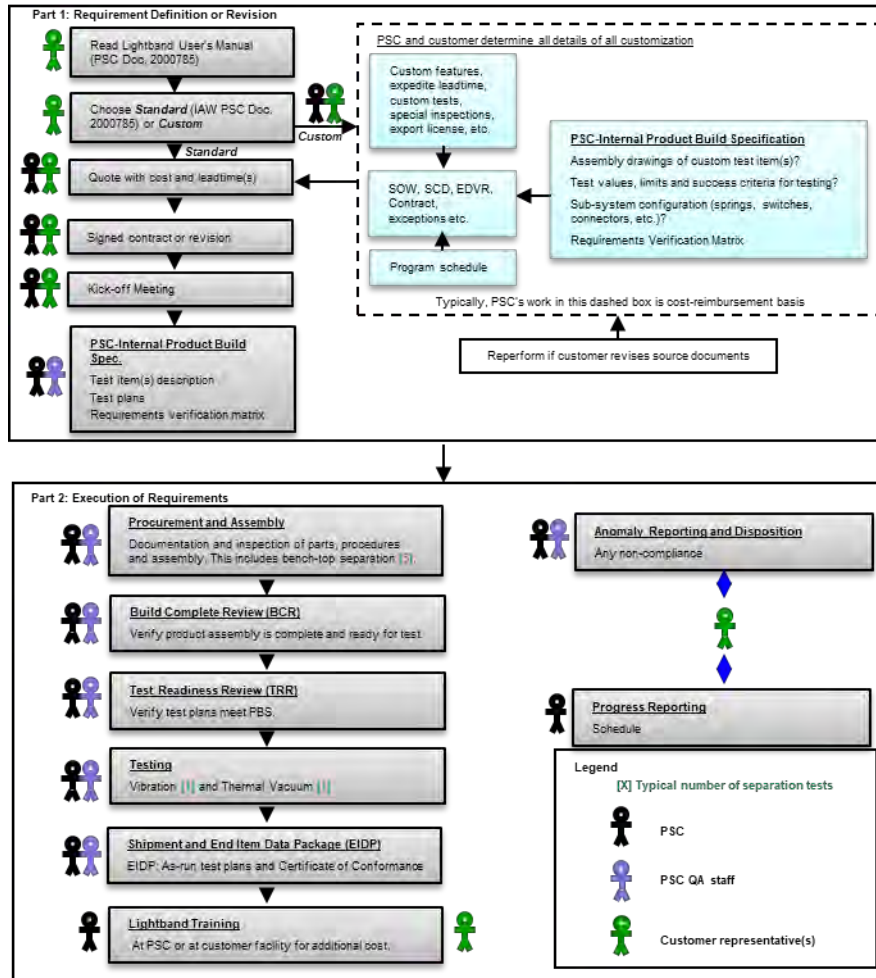

Figure 6-2: MLB selection and production process

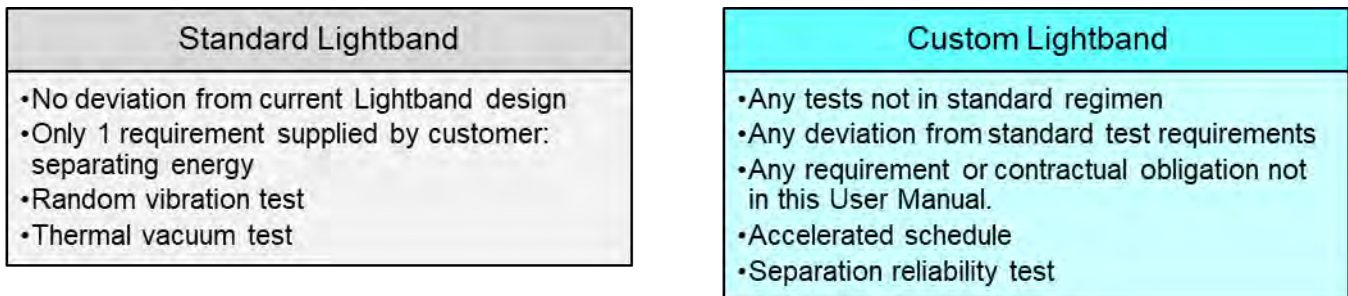

Figure 6-3: Standard vs. Custom MLB characteristics

Custom MLB Inquiry Item	Document Reference Section	Response [Y/N]
Is strength testing required?	16.2.2	
Is separation reliability testing required?	16.2.1	
Is any non-standard test required?	16.1	
Is a custom design modification feature required?	7.1	
Are non-standard rotation rates required?	16.2.1	
Does the payload have a Y_{LB} or Z_{LB} C.M. offset that must be simulated in separation reliability testing?	7.21 & 16.2.1	
Is the separating energy outside the range in Table 5-1 required?	5	
Is the separation energy tolerance tighter than Table 16-2 value required?	16.2.1	
Are requirements outside of this User Manual being referenced in a statement of work (SOW) or separate compliance document?	16	
If any of the above are answered as “yes,” the MLB shall be classified as Custom.		

Table 6-1: Standard vs. Custom MLB selection checklist

(Note: checklist is not all-encompassing, there may be additional unlisted items which necessitate Custom classification)

6.3 Lightband Size Determination

The following steps shall be completed by the customer to determine the correct MLB for their mission requirements. Steps 6.3.2 through 6.3.7 are often an iterative process.

6.3.1 Read this manual

If you thoroughly understand the MLB, you will be in the best position to avoid costly test failures and program delays.

6.3.2 Determine stiffness requirements

The biggest driver in MLB diameter selection should be payload stiffness requirements. From dynamic envelope mission requirements, determine the required axial and lateral stiffness of the payload stack. The minimum MLB diameter can then be selected from Table 5-1. However, it is prudent to choose an MLB diameter larger than necessary to provide additional stiffness margin at less than an equivalent increase in weight. For example, a 15 inch diameter MLB is about 6.6 times stiffer than an 8 inch diameter MLB, but weighs less than twice as much. See Section 7.6.

6.3.3 Determine strength requirements

From your expected mission loads on the payload, calculate maximum line load via methods in Section 7.10. Verify that mission loads required to attain those line loads are less than maximum MLB loads shown in Table 5-1. If not, increase the chosen MLB diameter until allowable line load is achieved. See Section 16.2.2.

6.3.4 Determine cyclic loading and fatigue requirements

Ensure the mission vibration environment produces allowable line loading per Section 7.14. If not, increase the chosen MLB diameter until allowable line load is achieved.

6.3.5 Select an MLB diameter (bolt circle diameter)

Choose an appropriate MLB diameter from Table 5-1 based on stiffness, strength, cyclic loading, and fatigue requirements.

6.3.6 Determine separating energy

Determine the separating energy that results in the desired separating velocity of the payload relative to the final stage. See Section 7.22 to calculate the desired separating energy. A separating energy outside the allowable range in Table 5-1 shall be considered a custom MLB. The standard separating energy tolerance is ± 2.0 J.

If no separating energy is provided PSC typically defaults to minimum number of Separation Springs as specified in Table 5-1.

6.3.7 Complete virtual fit check and plan logistics

Integrate both the MLB stayout zone model and a CAD model of the MLB (download from www.planetarysystemscorp.com or contact PSC) with a model of your payload and verify your fit requirements. Pay close attention to all stayout zones per Table 5-1 as the CAD model may not represent the maximum travel of all components. Remember to include your wiring harness. Also determine how you will fasten and operate the MLB for shipment, testing and final integration procedures. Determine the electrical and mechanical ground support equipment (GSE) needed. Also review *2000781 MkII MLB Operating Procedure*.

6.4 Specifying an MLB

Use the following convention to specify the MLB: MLBXX.XXX-SW-SC-LCT-FLT-E.E

Required Prefix	Bolt Circle Diameter [in]	Separation Switch Qty. [-]	Separation Connector Qty. [pair]	Lightband Compression Tool Qty. [pair]	End Use (FLT or EDU)	Separating Energy [J]
MLB	XX.XXX	SW	SC	LCT	FLT	E.E

Table 6-2: MLB specification convention

For example, **MLB15.000-0-1-8-FLT-6.1** specifies

- 15 inch bolt circle diameter MLB with
- 0 Separation Switches
- 1 Separation Connector pair (1 lower connector and 1 upper connector)
- 8 Lightband Compression Tool pairs
- be used for space flight and thus receive standard acceptance testing
- have nominal flight separating energy of 6.1 J.

Using this convention will ensure that MLB requirements are unambiguous.

Note: A Standard MLB includes 1 Separation Connector pair and 1 Separation Switch.

Contact PSC by email (psc.info@rocketlabusa.com) or phone to finalize the selection and purchase of an MLB.

6.4.1 Separation Switch quantity (SW)

The greater the quantity of Separation Switches, the more complex and heavy the harness. See Table 5-1 to ensure the total quantity of Separation Switches and Separation Connectors does not exceed the maximum allowable.

6.4.2 Separation Connector quantity (SC)

As with Separation Switches, fewer Separation Connectors allow for a simpler harness. Connectors are specified as pairs, so one Connector consists of both the lower and upper halves. At least one Separation Connector is required to ensure conductivity through the MLB because the Upper Ring is anodized. See Table 5-1 to ensure the total quantity of Separation Switches and Separation Connectors does not exceed the maximum allowable.

6.4.3 Lightband Compression Tool quantity (LCT)

A means to compress the MLB halves before stowing is required. If the weight of the payload is less than total Separation Spring force, or horizontal integration is required, Lightband Compression Tools (LCTs) will be required. See Section 15.3 to calculate the required quantity. See Table 5-1 to determine the maximum allowable qty. for a specific MLB size.

6.4.4 End Use (FLT or EDU)

Engineering Development Unit (EDU) Lightbands receive only a bench-top separation test. They do not receive acceptance testing and shall not be used for flight. As such, EDUs are indelibly marked "**NOT FOR FLIGHT.**"

Flight Units (FLT) receive the full slate of standard acceptance testing prior to shipment.

EDU and FLT MLBs are built using the same materials and processes. Customers often purchase an EDU in addition to a FLT for fit checks and ground testing.

6.4.5 Separating Energy (E.E)

Specify the desired separating energy rounded to the nearest 0.1 J. See Section 6.3.6.

7. Mechanical Properties

7.1 Dimensions

The dimensions shown in Figure 7-1 and Figure 7-3 as variables vary with diameter and are defined in Table 5-1. Dimensions 'C' and 'D' include the separation event when the Retaining Ring and Sliding Tube snap inward. They extend the entire height of the MLB. Dimension 'B' extends the height of the Upper Ring, 'F', and is useful after deployment if the satellite has deployables. The dimensions shown as constants do not vary by diameter. The customer-supplied wiring harness is not shown. Harness design, discussed in Section 8.3, can substantially increase the volume associated with the separation system.

A CAD model of these stayout zones is available for download at www.planetarysystemscorp.com in STEP format.

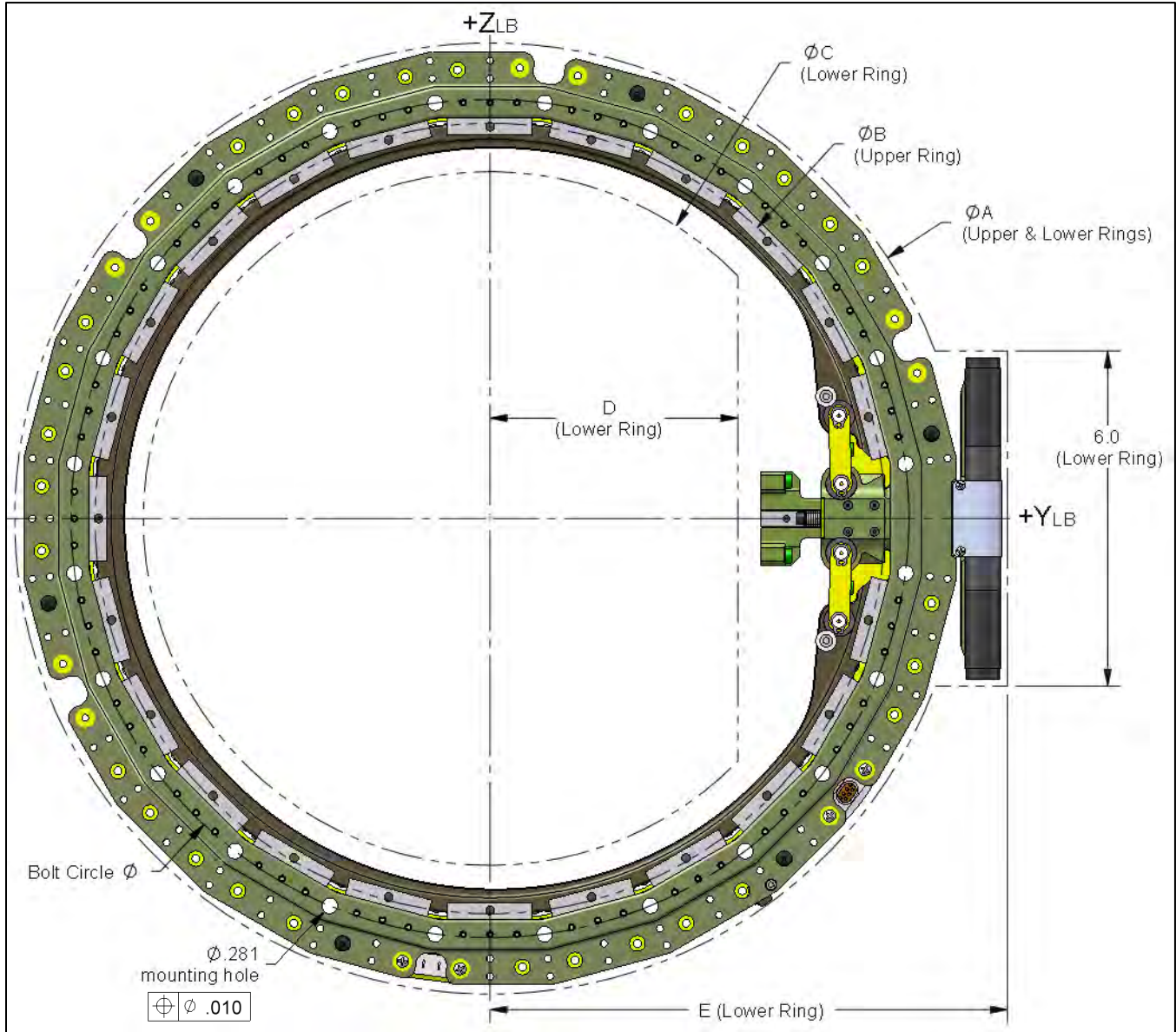

Figure 7-1: Top view of the MLB, see Table 5-1 for variable dimension values

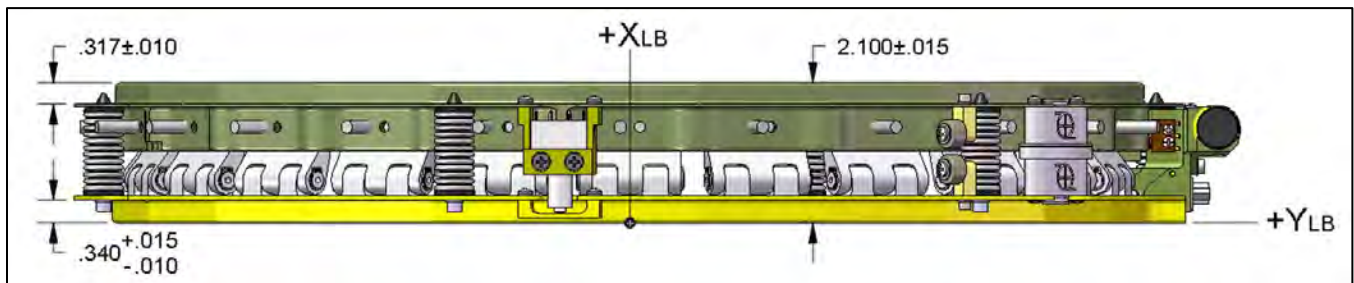

Figure 7-2: Side view of the MLB

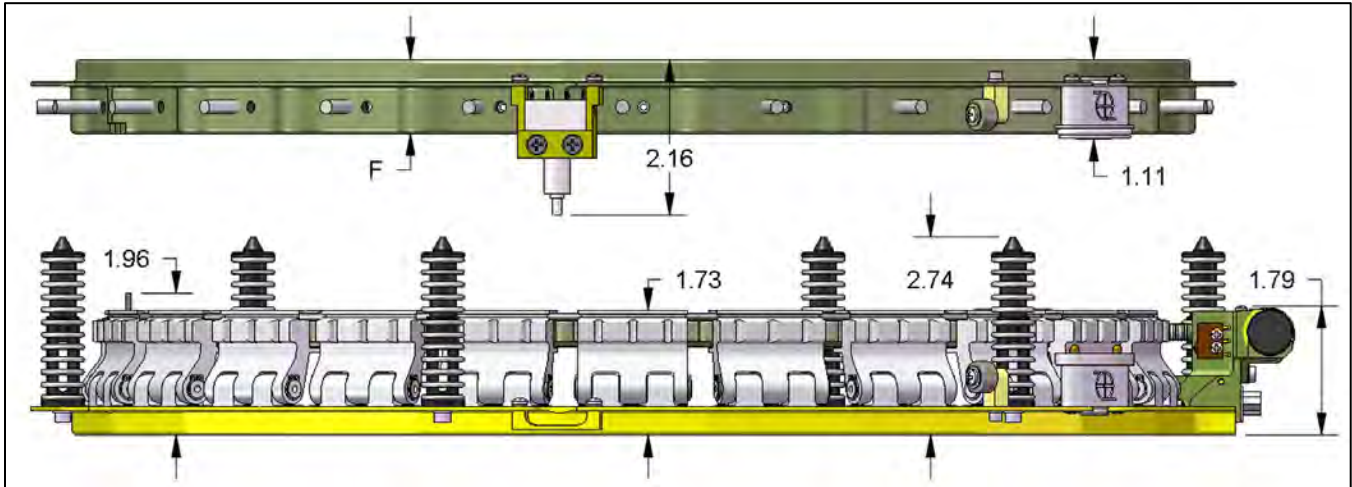

Figure 7-3: The deployed (or separated) view. The Springs and Switches are shown fully elongated

7.2 Tolerance on Dimensions

Distance tolerances are shown in Table 7-1.

Precision	Tolerance [unit]
x.xxxx	± 0.001
x.xxx	± 0.005
x.xx	± 0.010
x.x	± 0.030
x	± 1.000

Table 7-1: PSC distance tolerances

7.3 MLB Description

The coordinate system for the MLB is shown below. The $+X_{LB}$ axis originates from the Lower Ring bottom plane and points towards the Upper Ring. The $+Y_{LB}$ axis passes through the center plane of the Motor Bracket Assembly. The MLB Upper and Lower Rings are engraved with $+Y_{LB}$ and $+Z_{LB}$ during manufacture. Unless otherwise noted, all axes in this document refer to the MLB coordinate system and all dimensions are given in inches.

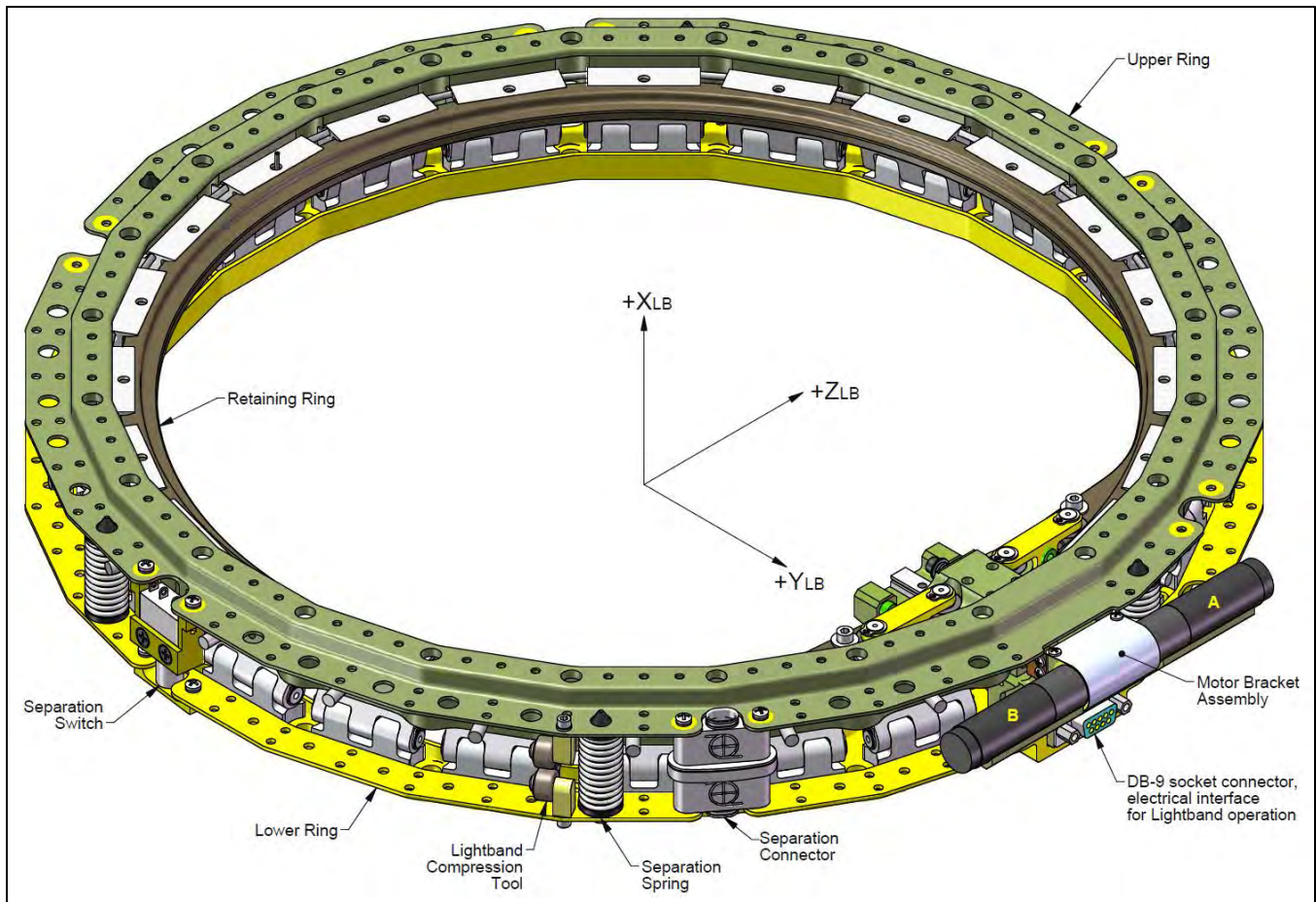

Figure 7-4: 15 inch diameter MLB shown stowed

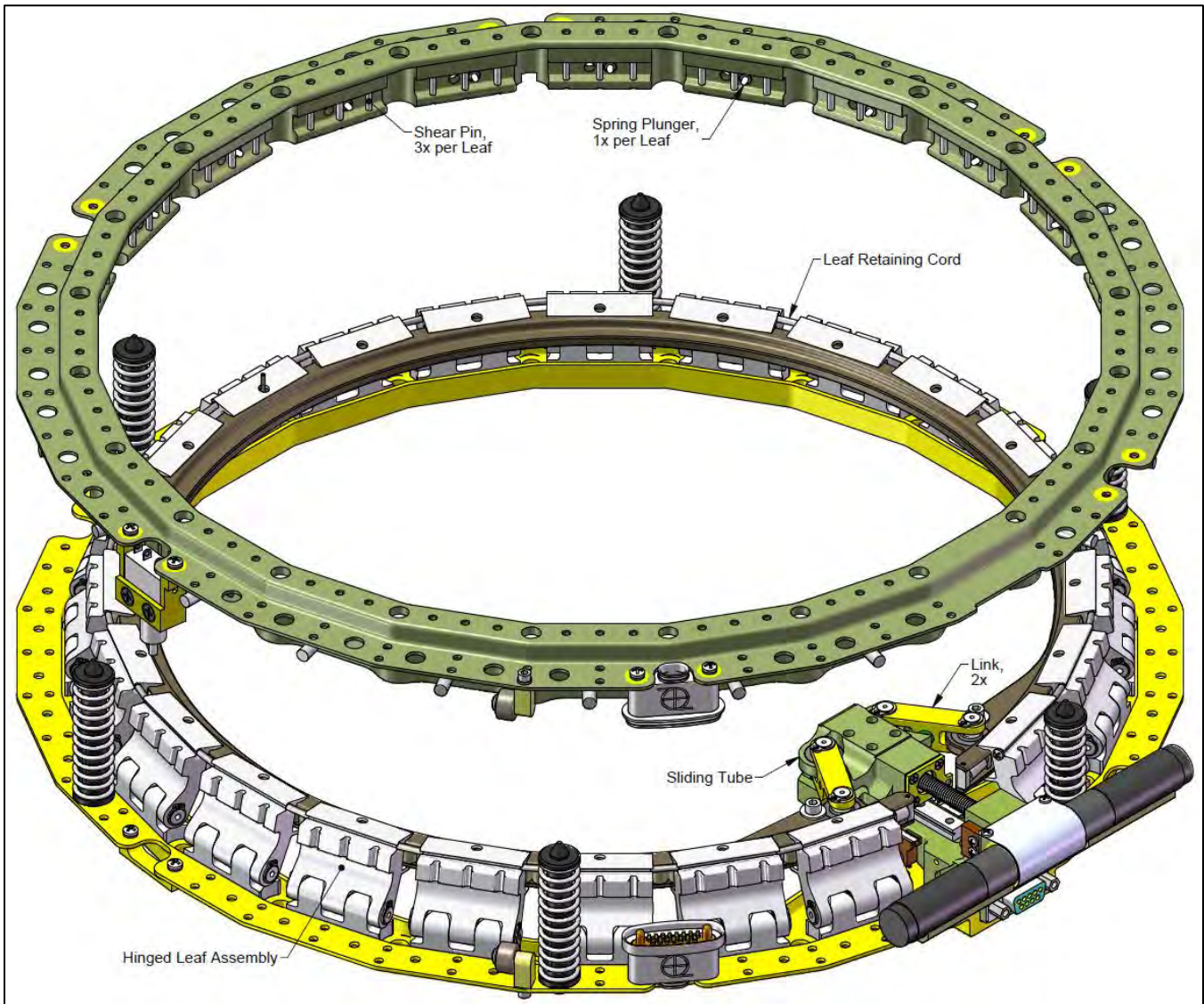

Figure 7-5: A 15 inch diameter MLB shown deployed



Figure 7-6: The Leaves disengaged during deployment, (section view)

7.4 How the MLB Works

Videos showing the MLB operating on the ground and on-orbit are available at www.planetarysystemscorp.com.

Figure 7-7 shows the MLB in the stowed/set-for-flight state. The Retaining Ring is in compression (black arrows) pressing the Leaves outward into the Upper Ring. The Links are over-centered and the motors are not powered.

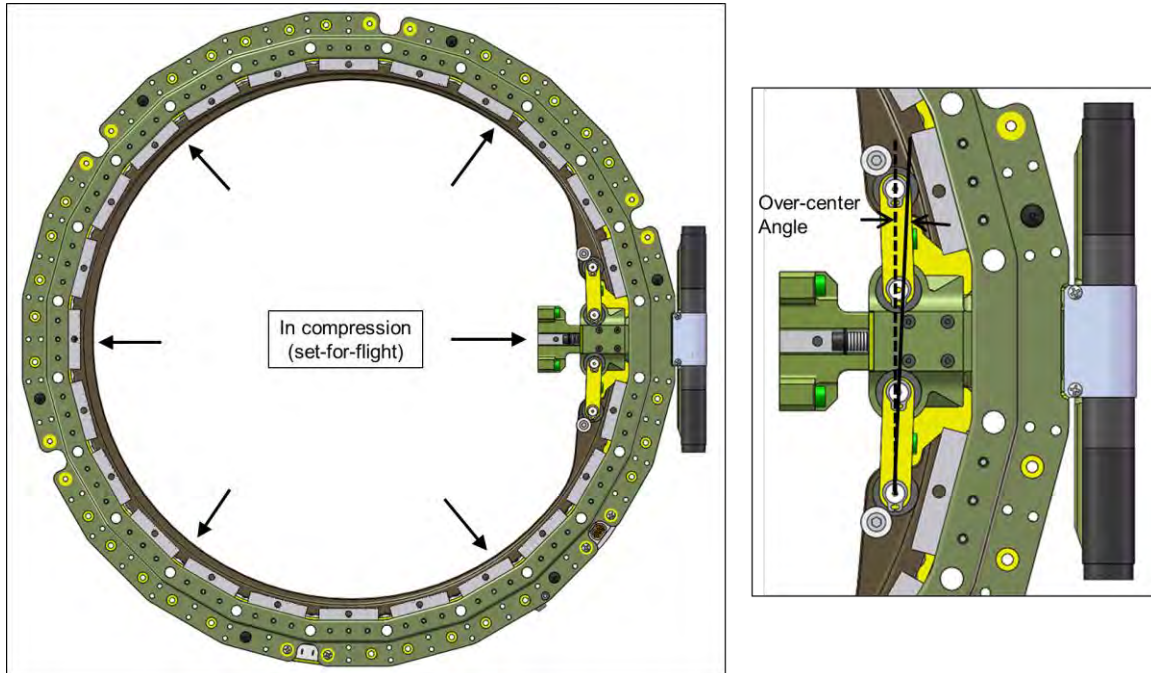

Figure 7-7: The MLB in the stowed or set-for-flight state

Figure 7-8 shows the MLB in the initiated state. Upon deployment initiation the motors are powered causing the mechanism to snap inward in approximately 0.060 s. This allows the Retaining Ring to retract.

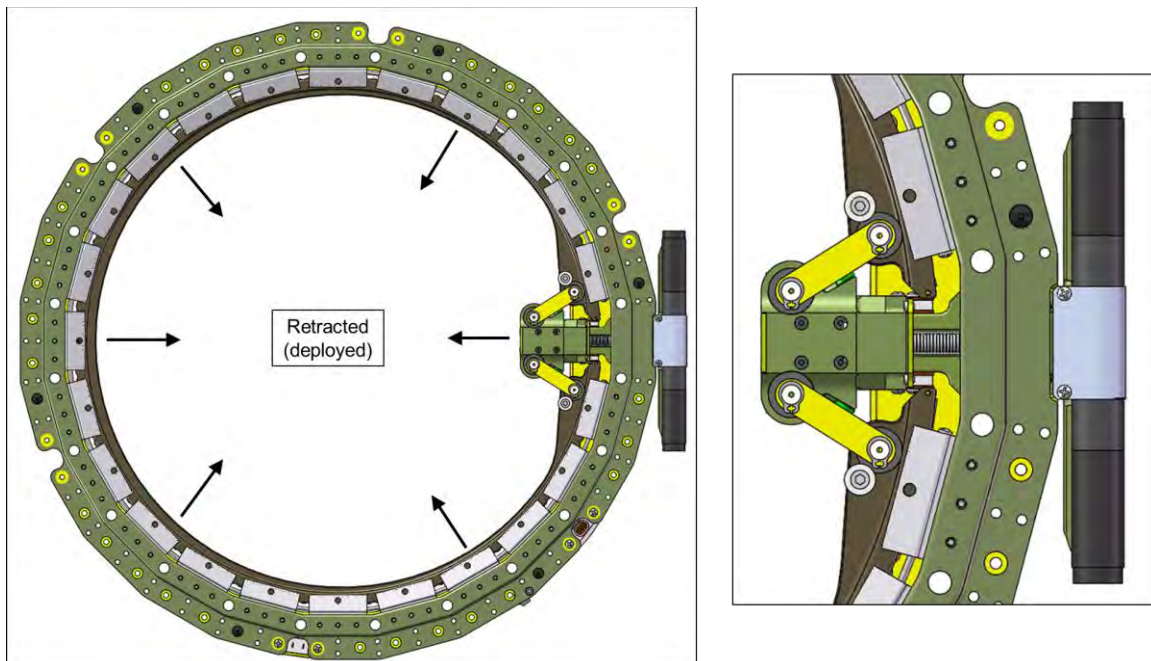

Figure 7-8: The MLB in the initiated state

After the motors initiate and the Sliding Tube snaps inward, the Retaining Ring releases its stored compression energy and no longer reacts the inward Leaf Retaining Cord and Spring Plunger forces. The Spring Plungers, fastened to the Upper Ring, then cause the Leaves to disengage from the Upper Ring. The Upper Ring is then free to separate from the Lower Ring due to the force generated from the Separation Springs. See Figure 7-9 and Figure 7-10. The Leaf Retaining Cord provides a constant radial force inward that holds all the Leaves against the Retaining Ring so the MLB can easily be re-stowed during testing.

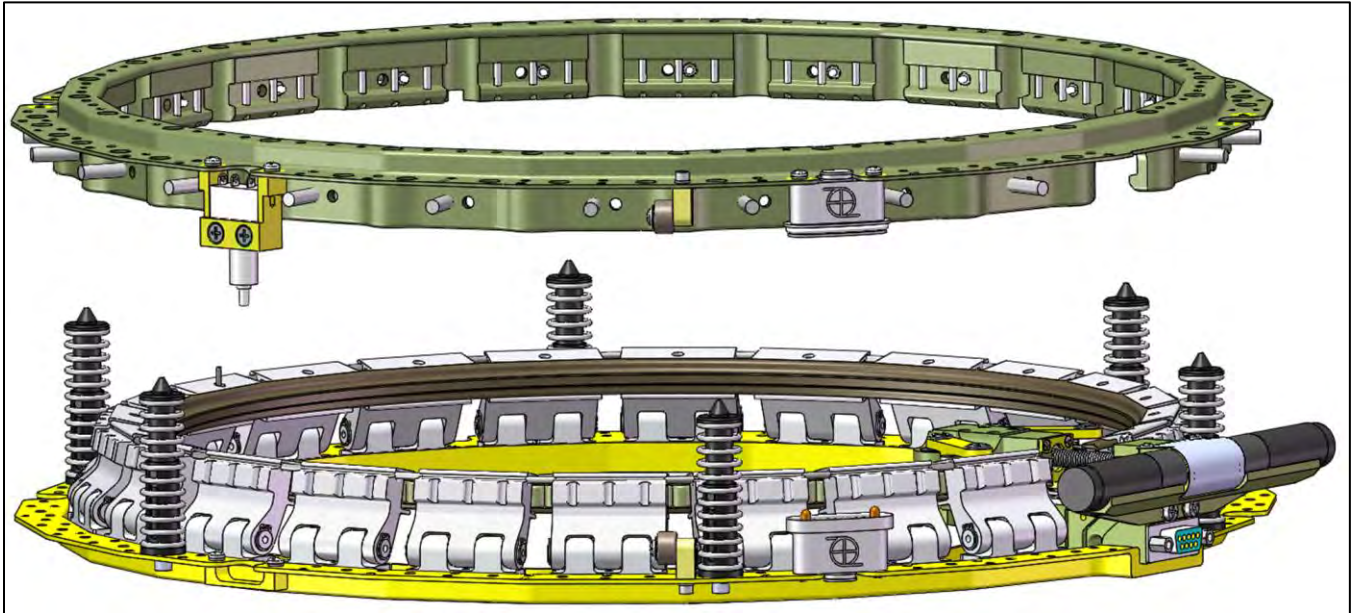

Figure 7-9: The MLB in the deployed (or separated) state

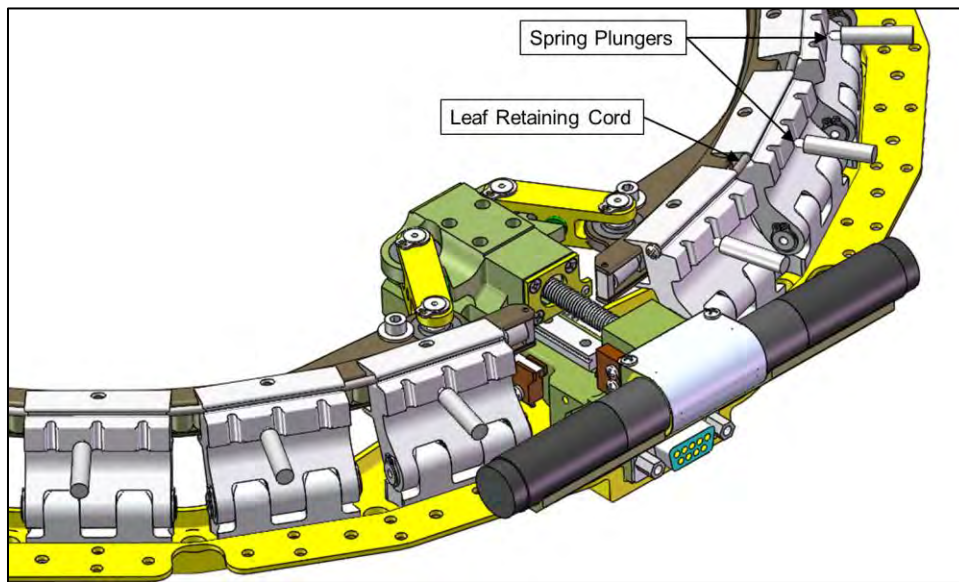

Figure 7-10: The Leaf Retaining Cord and the spring plungers shown in the deployed state (Upper Ring hidden for clarity)

Figure 7-11 illustrates the Leaves disengaging due to the force from the Spring Plungers, allowing the Separation Springs to push the rings apart.

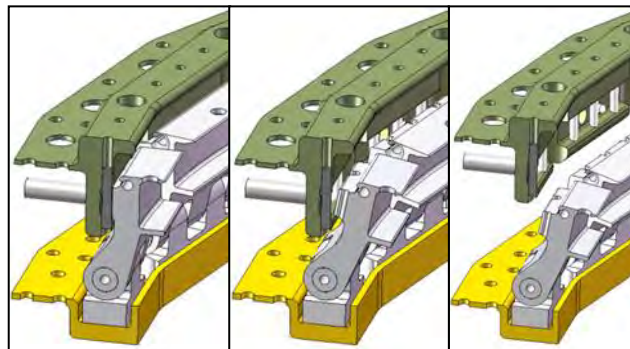

Figure 7-11: The MLB shown deploying (or separating)

7.5 How the Motor Bracket Assembly Works

The Motor Bracket Assembly (MBA) is the actuator of the MLB. In the MBA, two DC brush motors connect to bevel gears. Stainless steel bevel gears connect to a brass common bevel gear and that common bevel gear connects to the ball screw. The ball screw connects to a ball nut which bears upon the Stow or Deploy End Plate at the ends of the Sliding Tube, depending on the MLB operation. The Sliding Tube encloses the ball nut and is fastened to the linear way which slides on the rail. The Sliding Tube is connected to the Links via spherical bearings which in turn control the motion of the Retaining Ring.

The Motor Bracket constrains the linear motion of the Sliding Tube with elastomeric (non-outgassing) Deploy Stops at the deploy end and with hard stops at the stow end. The lubricants, Braycote 601-EF and molybdenum disulfide, are space-qualified and non-outgassing. The Stow and Deploy Limit Switches are arranged to cut power when operational physical limits (stow, set-for-flight, and deploy) are reached.

All of the set screw junctions in the MBA are redundant and bear upon flats or engage bores. All fasteners are staked with Arathane. The motors are redundantly fastened to the Motor Bracket and staked to the Motor Support. The pinions between Motor A/B and Planetary Gearhead are connected to the motor shafts redundantly (welds on both faces of the pinion gear). Except for the spherical bearings, there is no sliding friction; all motion in this assembly is strictly rolling.

It takes more power and energy to stow than deploy the MLB. Therefore, as a reliability feature, stowing the MLB verifies substantial torque margin for deploying. If the MLB cannot be stowed, it cannot fly. The set-for-flight operation verifies proper functionality and torque margin in the flight configuration. The MLB will deploy with only one motor.

A flex circuit connects the limit switches and motors to the DB-9 socket connector fastened to the Motor Bracket. Section 8 of this document describes electro-mechanical operation of the MLB.

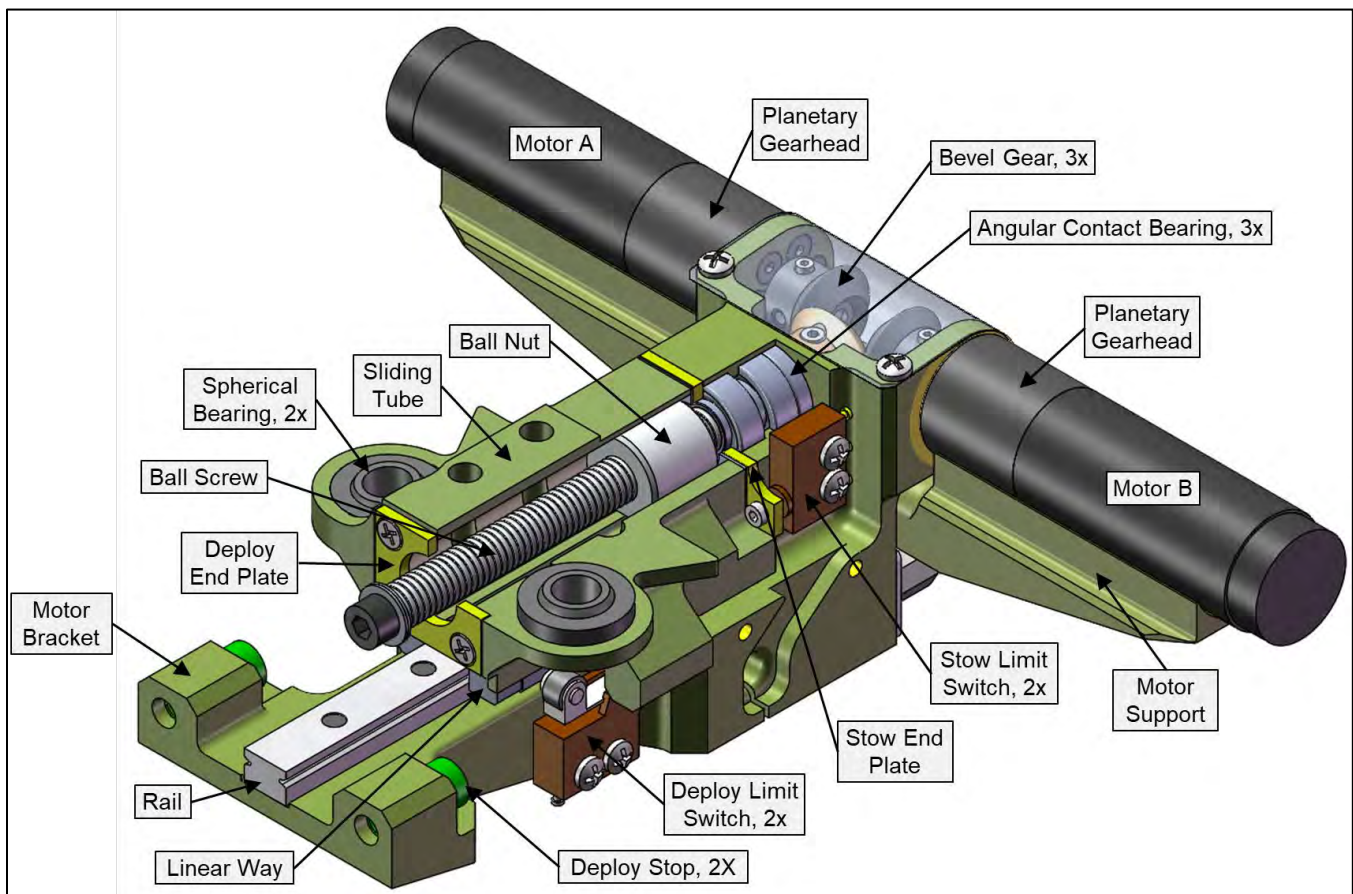

Figure 7-12: Motor Bracket Assembly shown in the stowed state (some parts sectioned for clarity)

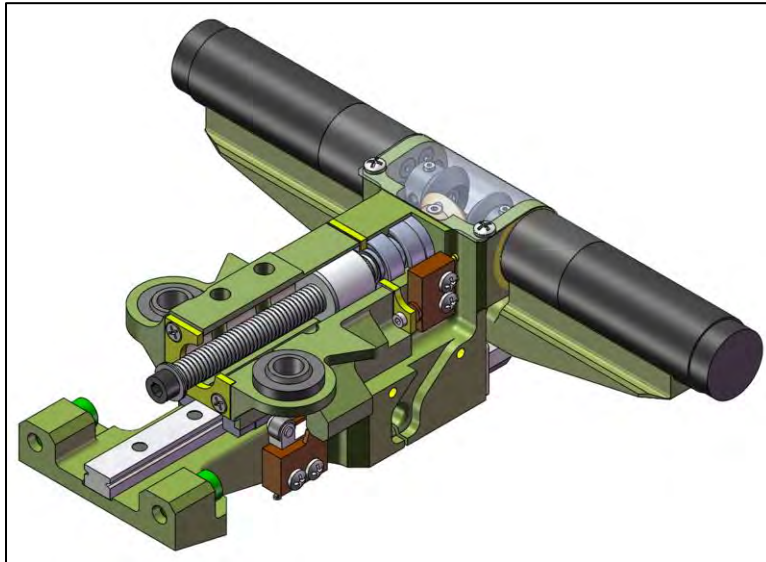

Figure 7-13: Motor Bracket Assembly in the stowed state

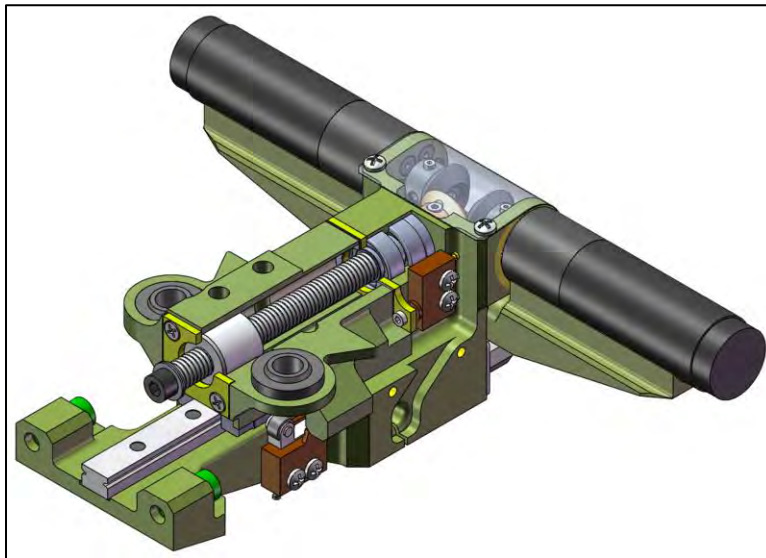

Figure 7-14: Motor Bracket Assembly in the set-for-flight state

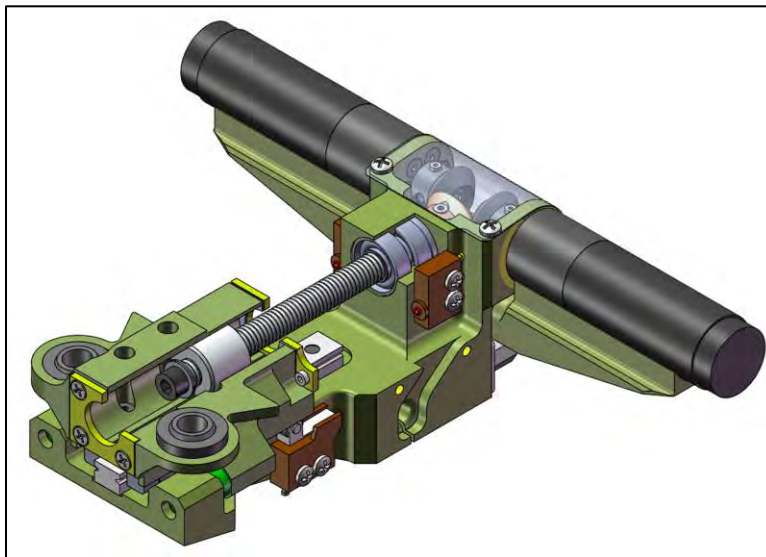

Figure 7-15: Motor Bracket Assembly in the deployed state

7.6 Stiffness

Stiffness is major design driver when determining which MLB size is required for a payload. Payload stack stiffness increases with the cube of the MLB diameter. For example, a 15 inch diameter MLB is about 6.6 times stiffer than an 8 inch diameter MLB, but weighs less than twice as much. Additionally, the first lateral mode frequency of the payload stack increases with the 3/2 power of MLB diameter. Often, customers select the smallest allowable MLB and thus payload stiffness is barely above allowable minimums. This can increase risk of mission failure due to unintended stack dynamics. Prudent customers often use a larger MLB diameter than required to gain stiffness margin with only a small increase in weight. Stiffness values are shown in Table 5-1. Higher fidelity stiffness estimations of the MLB can be determined via FEM.

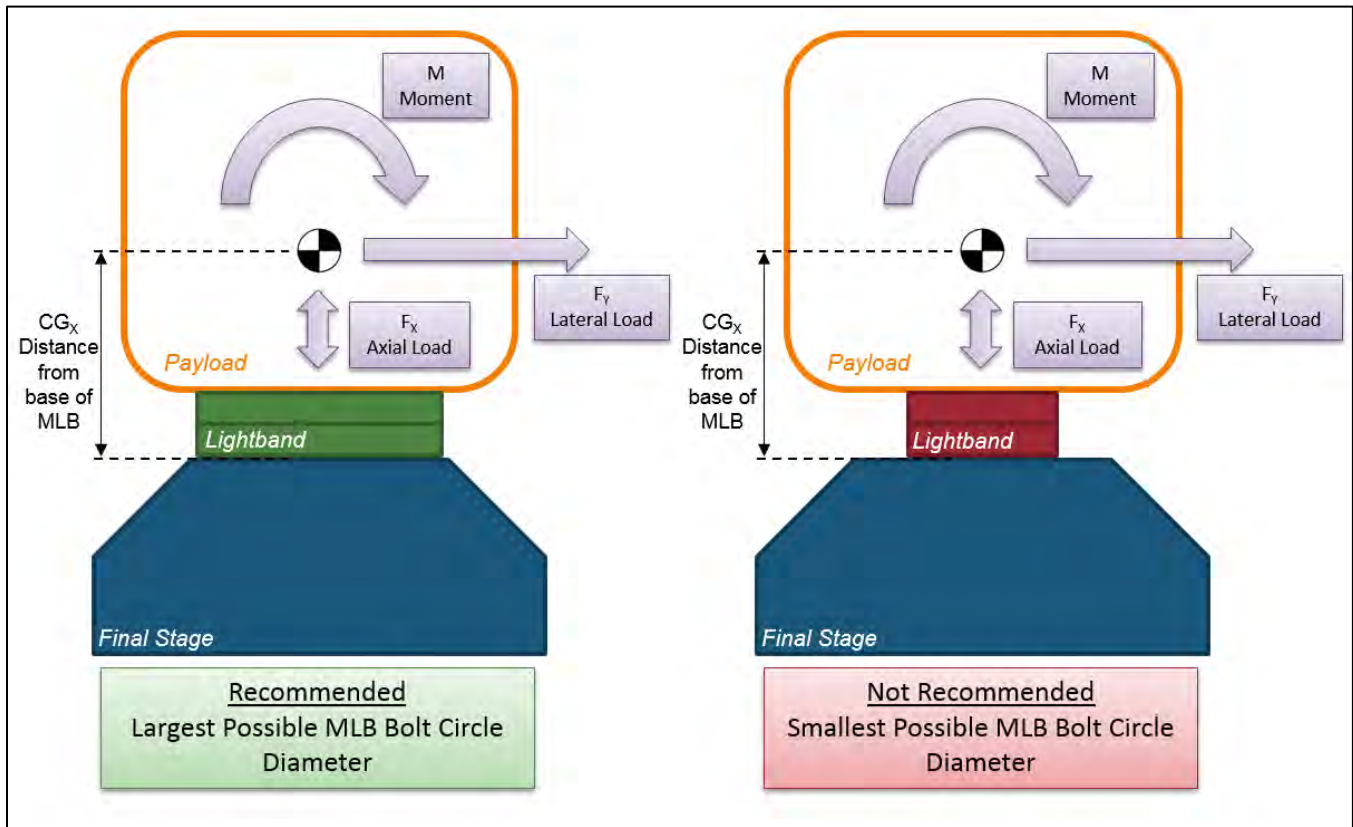

Figure 7-16: Larger diameter MLBs are stiffer and stronger than smaller diameters

7.7 Joint Compliance

The compliance of the bolted joint from the MLB to adjoining structures can have a substantial effect on the overall stiffness. The stiffness reported in Table 5-1 does not include joint compliance. Table 7-2 shows the normalized results of a study of stiffness for a specific MLB program and illustrates that joint compliance reduces stiffness in all directions. The data comes from the test of a 38.810 inch diameter MLB and is for example rather than design purposes.

It can be assumed that the effect of joint compliance on any size MLB is the same as shown in Table 7-2.

Item	Normalized X_{LB} Axis Stiffness [-]	Normalized Y_{LB} & Z_{LB} Axis Stiffness [-]	Normalized R_x Rotational Stiffness [-]	Normalized R_y or R_z Rotational Stiffness [-]
MLB without joint compliance	1.00	1.00	1.00	1.00
MLB with joint compliance	0.74	0.99	1.00	0.75

Table 7-2: The effect of joint compliance on stiffness

7.8 Discussion of Features on Adjoining Structures

In order to maximize the stiffness of the satellite stack including the MLB, engineers should design robust features in the structures adjoining the MLB. As the analysis in Table 7-3 shows, thick flanges, small moment arms, and chamfers (or large radii) create much stiffer and lighter structures.



Design	Deflection Plot	Design Notes	Max Deflection Value [in]
		<ul style="list-style-type: none"> •Flanges too thin •Moment arms too large •No chamfer or fillet 	0.0050
		<ul style="list-style-type: none"> •Thicker flanges •Smaller moment arms, but fits fasteners •Chamfer added for stiffness •No significant increase in mass 	0.0002

Table 7-3: Features of adjoining structure²

The stiffness of flanges are important relative to overall stack stiffness. If the flange stiffness is too low the first mode lateral frequency of the entire stack can decrease detrimentally. For proper operation of the MLB, the flanges should be stiff enough to guarantee the preload of the MLB will not excessively warp the adjoining structure and vice-versa.

Warning: adjoining structures with excessive flexibility can cause failures.

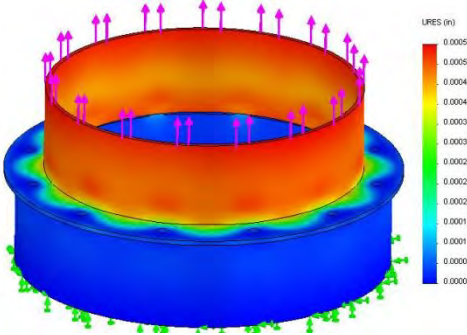
PSC attaches custom Transition Rings (PN 2000741) to the Lower and Upper Rings of the MLB for all operations. A drawing of the Transition Rings is available for download from the website. Ensuring the adjoining structure's stiffness is equivalent or greater than these Transition Rings is recommended to ensure proper operation.

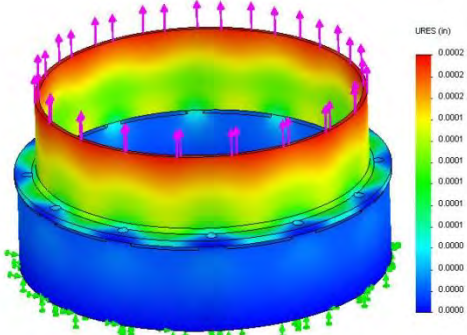
² The lower cylinder represents a Lightband. The upper cylinder with flange represents an adjoining structure. The applied load is 1,000 lb. The materials are aluminum.

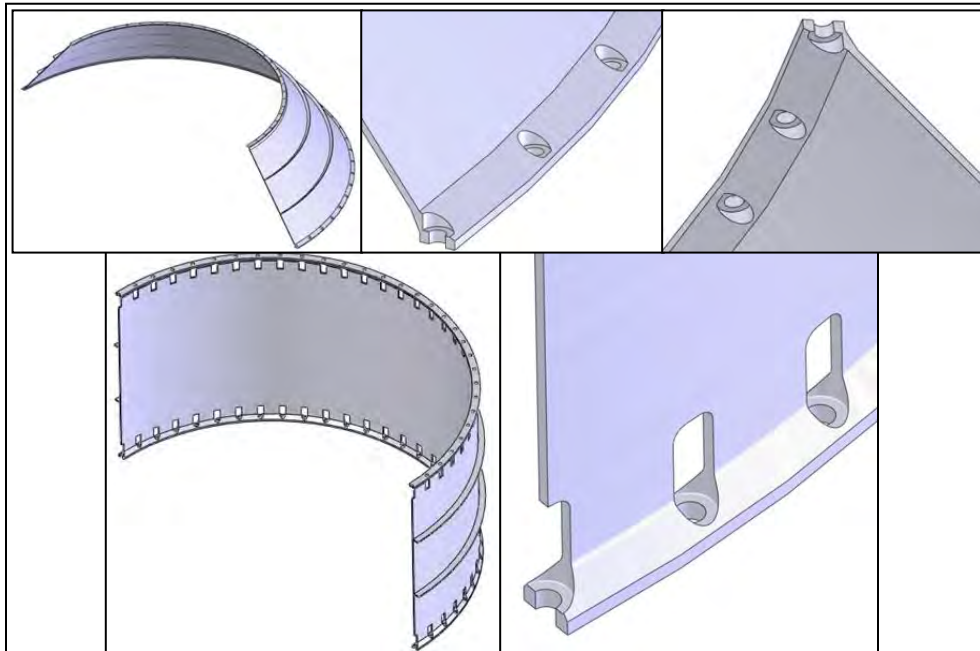

Figure 7-17: Structures with optimal flange design. Moment arms in the flange are minimal, maximizing stiffness and strength

As noted in Table 5-1, there are two sets of required flatness for adjoining structure values. Though somewhat subjective, if the adjoining structure is relatively stiff, the required flatness will be tighter than if the adjoining structure is relatively flexible. A relatively flexible structure will conform to the flat interface better than a relatively stiff one. See Figure 7-18. If in doubt about the stiffness of your adjoining structure, please contact PSC.

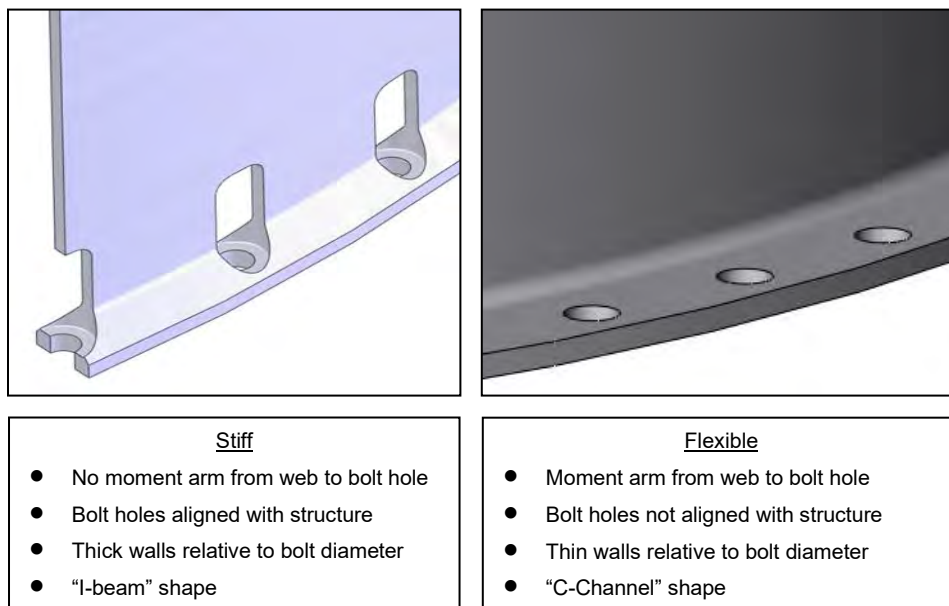

Figure 7-18: Example of stiff and flexible adjoining structures

The type of adjoining structure can also have an effect on operation and integration of the MLB. Customers should be aware of the effects of their choice of adjoining structure before integration and adequately plan for any likely issues. See Table 7-4.





	Lightband Adjoined to...		
	Stiff Weldment, Ring, or Plate	Transition Rings	Isolation System
Typically Characterized As (See Table 5-1)	Stiff	Flexible	Flexible
Most Similar Type of Flight Adjoining Structure	Adapter plate or base plate	Adapter cone or ring	Isolation system
Flatness	Often difficult to manufacture within required flatness tolerances.	Typically meets flatness requirement.	Reduces flatness requirement.
Lightband Flexure	Often too stiff, does not allow Lightband to flex enough during operations.	Allows Lightband to flex nominally and maintains required stiffness during operation.	Provides best chance for successful Lightband integration and operation.
Shimming	Difficult to meet flatness requirements via shimming.	Less difficult to meet flatness requirements via shimming.	Not necessary.
Relative Cost to Manufacture/Procure	Low	Medium	High
Relative Cost to Ensure Manufactured Flatness	High	Medium	N/A
Side View			
Isometric View			

Table 7-4: Comparison of MLB adjoining structures

7.9 Fasteners to Adjoining Structures

PSC does not provide fasteners to adjoining structures. However, PSC typically uses ≥ 160 ksi socket head cap (SHC) screws torqued 100 to 115 in-lb. Exceptions to this torque specification have been made during qualification tests in order to prevent bolted joint slipping.

.25 inch SHC screws with small pattern washers are recommended when fastening from the Upper or Lower Ring to adjoining structures. The washer shall have OD $< .490$ inch. The through holes in the Upper and Lower Rings are $\varnothing .281 \pm .005$ inch and the position tolerance is $\varnothing .010$ inch. See Figure 7-1. This is beneficial in the assembly process because fasteners are easier to install but it limits the capacity of fasteners to guarantee alignment of structures to the MLB.

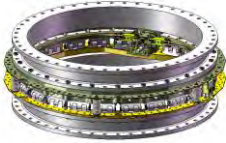
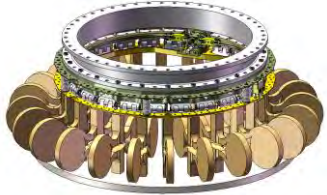
For 15 inch diameter MLBs, PSC recommends the use of reduced head diameter .25-28 SHC screws to fasten the Lower Ring to adjoining structures. This prevents interference between the fasteners and the Leaves described in 2000781 MLB Operating Procedure. The head diameter should be .340 inch. See Section 22.

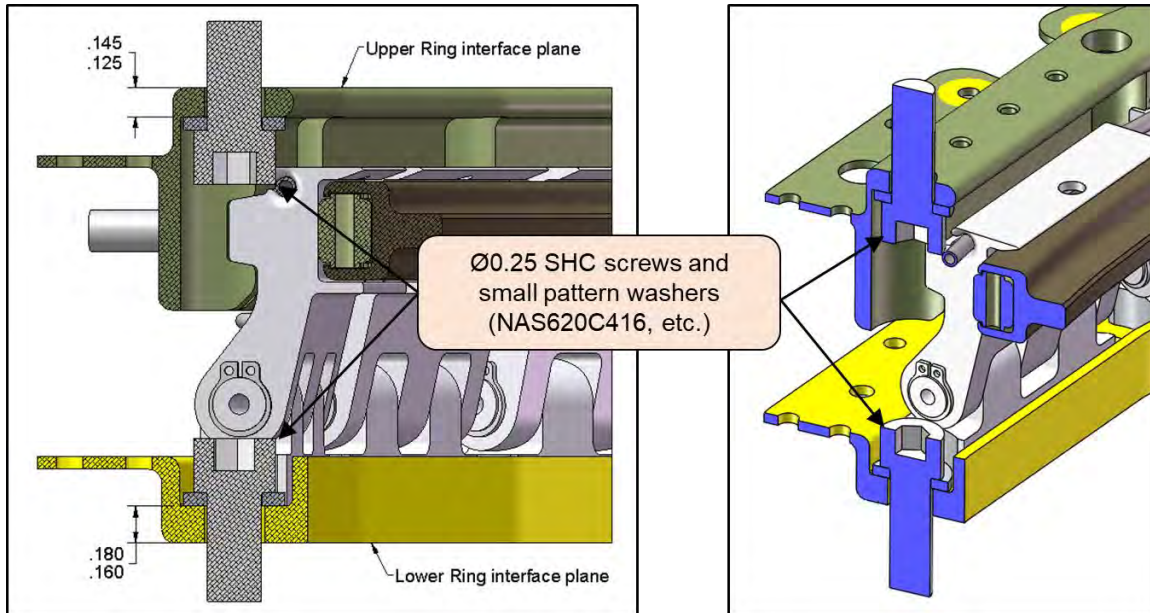

Figure 7-19: 0.25 inch fasteners from MLB to adjoining structures

Fasteners must be installed at every location in order to integrate the MLB. Do not skip a bolt as this will substantially decrease strength and stiffness of the MLB.

The thermal extremes of the bolted joint often drive the selection of fasteners. Users anticipating temperatures beyond $+10$ to $+50^{\circ}\text{C}$ should examine the preload changes associated with coefficient of thermal expansion (CTE) mismatch. In the past, missions on the Space Shuttle have driven bolted joint design to extremes because joints are expected to survive landing loads at very low temperature (-40°C). NASA-STD-5020 document outlines a thorough bolted joint analysis.

Stiffness is affected by bolted joints. Generally, greater preload leads to greater stiffness.

Ideally, the MLB should be fastened to adjoining structures when the MLB is separated. This allows easy access to the fasteners with tools. When the MLB Rings are mated together, barely sufficient access to fasteners is available from the inside of the MLB. It is essentially impossible to fasten a mated MLB to adjoining structures if access to fasteners is only available from the outside of the MLB.

7.10 Line Load Limits

Line loading in the X_{LB} axis arises from loads in the X_{LB} direction and moments about the Y_{LB} or Z_{LB} axis. Generally, the moments about Y_{LB} and Z_{LB} generate higher line loading than axial loads. In other words, lateral load cases are typically the limiting factor in strength margin.

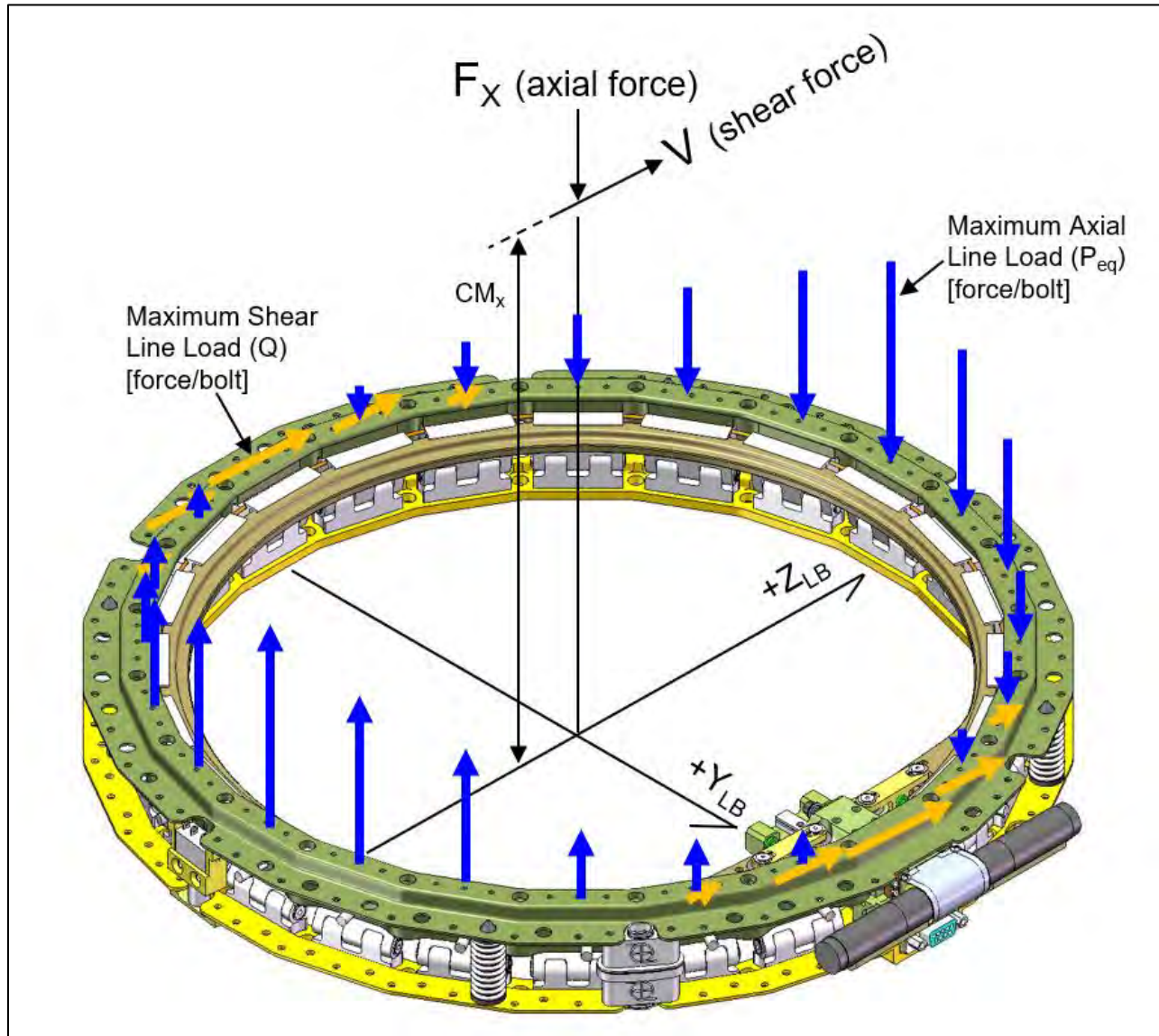

Figure 7-20: Line loading forces

Force per Bolt	Direction	Qualification Load [lb/bolt]	Max. Allowable Customer Load [lb/bolt]
P_{eq}	X_{LB} (Axial)	1,880	1,504
Q	Y_{LB} or Z_{LB} (Shear)	774	619

Table 7-5: Line load limits

In Table 7-5, the Qualification Load values are conservative as no yield or cracking has ever been detected on an MLB after test to these limits. The Maximum Allowable Customer Loads are the Qualification Loads divided by a 1.25 factor of safety. These values shall be reduced per section 7.14 to account for fatigue due to cyclic loading.

Each Leaf corresponds to thru-holes for fastening to the adjoining structures. The thru-holes are sized for 0.25 inch socket head cap screws. PSC analysis and tests have shown that the as-designed fastener hole size and spacing is optimum for MLB operation. All testing at PSC is performed with 0.25 inch fasteners because PSC test cells have 0.25-28 accepting threads.

Axial line loading arises from axial (X_{LB}) and lateral (Y_{LB} or Z_{LB}) loading and moments about Y_{LB} or Z_{LB} , whereas shear line loading arises from lateral (Y_{LB} or Z_{LB}) loading and moments about X_{LB} . In flight, lateral loads tend to make the greatest contribution to line loading. Maximum lateral load and axial load do not occur at the same time and standard PSC strength testing reflects this fact.

Note that PSC documentation sometimes expresses line loading in terms of force/Leaf instead of force/bolt. MLBs naturally have 1 less Leaf than bolt, but the difference in line load value from this computation method is accounted for in PSC qualification testing. Thus, the terms force/Leaf and force/bolt are interchangeable.

Magnitude of maximum axial line load is given by Equation (1). Direction of maximum axial line load is the same as F_x .

$$P_{eq} = \frac{|F_x|}{n} + \frac{4|VX|}{nD} \quad (1)$$

Where:

P_{eq} is maximum axial line loading [force per bolt]

F_x is axial force [force]

n is the number of fasteners in the bolt circle [-] (n is one more than the number of Leaves)

V is lateral force [force]

X is the distance from the MLB origin to the load application point in the x direction (typically the center of mass in x dir) [length]

D is the bolt circle diameter [length]

Magnitude of maximum shear line loading is given by Equation (2):

$$Q = \frac{2}{n} \left(V + \frac{|M_x|}{D} \right) \quad (2)$$

Where:

Q is the maximum shear line load [force per bolt]

V is the lateral force [force]

n is the number of fasteners in the bolt circle [-] (n is one more than the number of Leaves)

D is the bolt circle diameter [length]

M_x is the maximum applied torsional moment about the X_{LB} axis (typically negligible in flight loading) [force x length]

The values in Table 7-5 were calculated by applying loads produced by Equation (1) and Equation (2) to an MLB in strength test. Because the Motor Bracket Assembly (MBA) occupies the space of one Leaf, the distribution of load is discontinuous. The Leaves adjacent to the MBA will carry a higher percentage of load. However, this is accounted for by the loads applied to the MLB in qualification strength tests. E.G. in the MLB8 Qualification Strength Test, a total axial load of 22,560 lbf was applied (22,560 lbf / 12 bolts = 1,880 lbf/bolt) while the MLB only has 11 Leaves.

As another example, Figure 7-21 below shows the actual line loading for each bolt on an MLB15 with an applied 21,975 lbf X-axis load. The calculated axial line load per Equation (1) was 916 lbf/bolt. However, actual peak loading near the Motor Bracket (angle = 0 deg) exceeded 1,000 lbf/bolt. When determining MLB strength margin, the 916 lbf/bolt value is used.

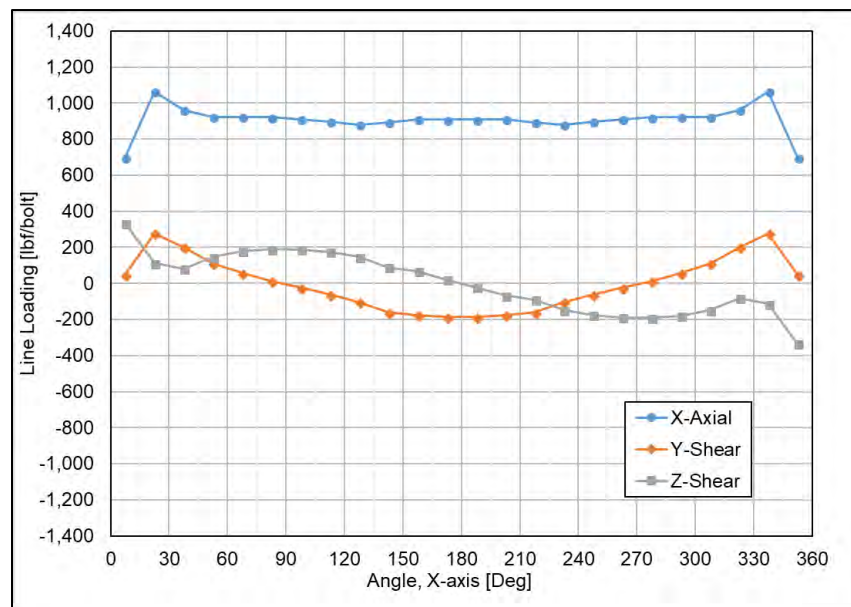

Figure 7-21: Line load peaking near Motor Bracket

The values listed in Table 7-5 do not however account for peaking due to stiffness variation of adjoining structures (e.g. base plate stiffening ribs, access cutouts, walls, etc.) Customers shall incorporate the MLB finite element model in their flight stack and determine the actual load distribution around the MLB. This will expose peaking due to adjoining structures and inform necessary derating. See Section 17.7.

The MLB behaves structurally like a thin-walled cylinder when stowed. Line loading may peak in areas where stiffness peaks. For example, if a MLB15.000 is installed on a rectangular satellite that has 15 x 15 inch base plate, line loading is expected to peak at the midpoint of the sides because the stiffest region of a satellite is at the midpoints. Engineers should design structures to the maximum allowable line load of the adjoining structures and ideally have a design that minimizes the extremes of line loading. Such a design is also structurally efficient as shown in the cylindrical satellite shape of Figure 7-22. Bolted joints to adjoining structures should be designed (at a minimum) to react the expected line loads.

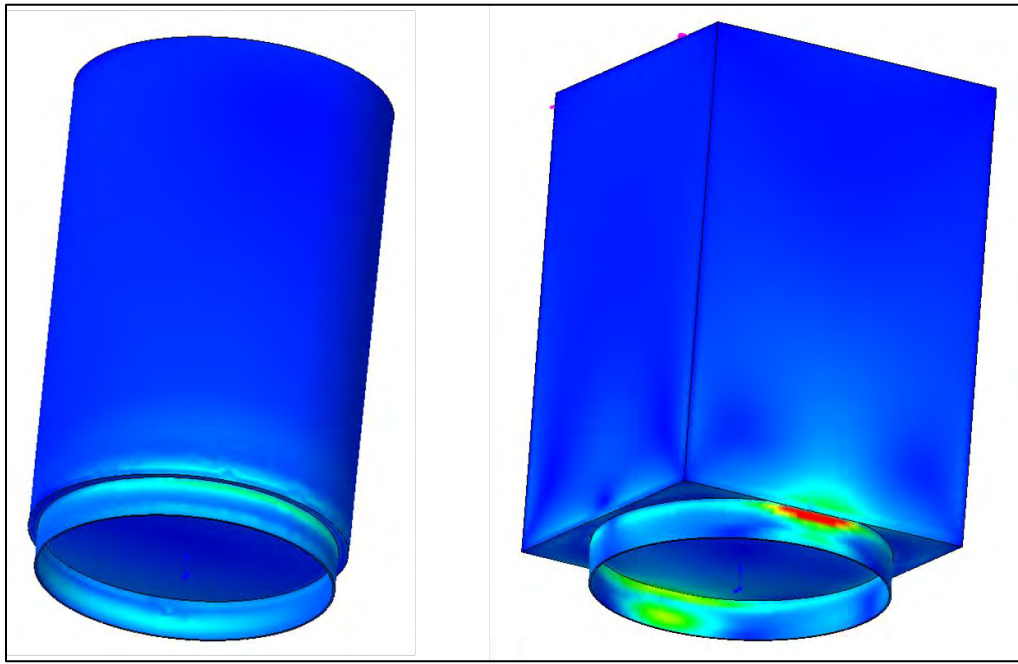

Figure 7-22: A round separation system and a square satellite can create high line loading

7.11 Flatness and Parallelism

Prior to joining to the MLB, the surfaces adjoining the MLB should be flat to the specification defined in Table 5-1.



Figure 7-23: An MLB attached to a launch vehicle cone and CAD model showing resulting stress peaking that occurs when adjoining two warped surfaces

When the adjoining vehicles are extremely warped or surfaces are not parallel, an attempt to join the MLB to both adjoining structures may break the MLB. Joining an MLB to only one adjoining structure will generally not increase stress because separation systems are designed to be more flexible than adjoining structures.

It may be tempting to design flexible features to attenuate stress exhibited in the warped structures that are joined. However, this can lead to an unacceptably low stiffness and first mode frequency of the entire system. To achieve both a low stress and high stiffness system, flatness of the adjoining structures must be controlled.

Isolation systems like Moog CSA Engineering's SoftRide intentionally add flexibility to joints to attenuate response. Furthermore, isolation systems offer an additional benefit in the substantial relaxation of adjoining structure flatness requirements.

Finite element models (FEMs) nominally assume perfect flatness of adjoining structures. Therefore, FEMs can obscure this potentially significant reduction in structural margin.

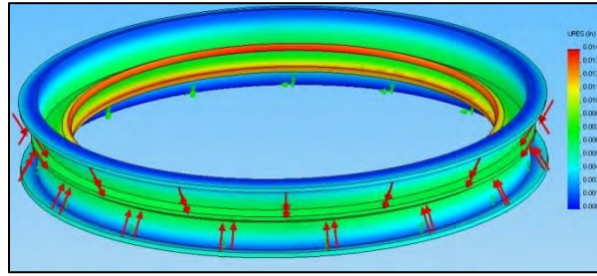

Figure 7-24: FEM simulates a clamp band separation system via radially inward preload from band tension. Warping can result.

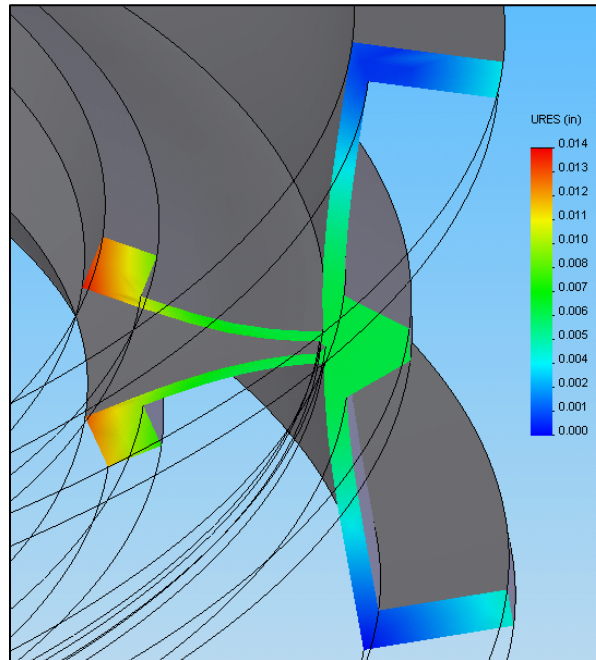

Figure 7-25: A deflection of 0.004 inches at the interface to adjoining structures is created by preload

MLBs and clamp bands embody the perverse nature of mechanical assembly; not only do they warp in proportion to preload, but a warp applied to them can affect their preload. Critically, as many mechanisms engineers have observed in test, the structural performance (strength and stiffness) is highly correlated to preload. PSC engineers often observe changes in internal strain as structures are joined to the MLB. A 20% change in preload as the separation system is fastened to an adjoining structure has been observed.

Easily-fabricated structures adjoining separation systems may be expensive to make flat. Alternatively, structures that may be expensive to fabricate can be easy to make flat. For example, a thrust cone that interfaces the final stage engine to the launch vehicle can be easily made by riveting machined rings to conical sheets. The riveting process can stress the thrust cone. This may manifest itself as warping (a lack of flatness) when the riveted structure is removed from its much more rigid tooling. To attain flatness requirements, the riveted structure must be machined or shimmed at additional cost. As a more expensive option, the thrust cone could be directly machined from a conical forging ensuring flatness requirements are met.

Engineers should consider the fact that all manufacturing and joining processes (riveting for assembly, fastening to adjoining structures, curing of composites) increase strain energy and thus will warp structures.

7.12 Damping Ratio

Damping ratio may be used to calculate the response of a structure attached to the MLB. A greater damping ratio reduces the response of the system at vibratory resonance. To estimate the damping ratio of the MLB, results of vibration tests of the MLBs with mass mock-ups attached were used.

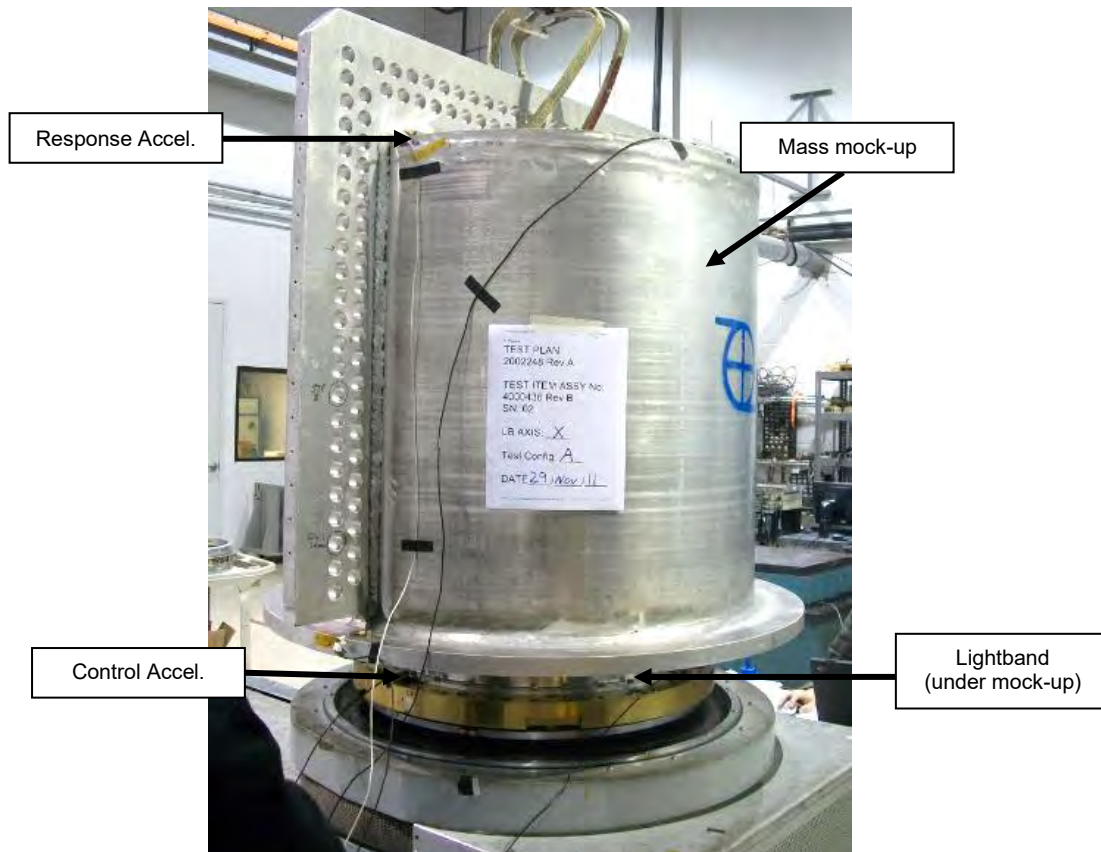

Figure 7-26: Vibration test of an MLB with a mass mock-up

Since the damping of the mass mock-up and the many bolted joints is included, the measured damping ratio must be higher than the MLB damping. To arrive at a conservative recommended MLB damping ratio, the test-measured damping ratios were reduced by 50% as shown in Table 7-6.

	X_{LB}-Axis	Y_{LB}-Axis	Z_{LB}-Axis
Measured damping ratio (d)	0.025	0.069	0.063
Recommended damping ratio (d)	0.013	0.035	0.032

Table 7-6: Damping ratio

The damping ratio can be calculated if one knows the quality factor, q , of a system's response at resonance. Quality factor is the ratio of output response level to the input level. In this case the input and output levels are of the unit gravitational force. The quality factor is defined in Equation (3).

$$q = \frac{1}{2d} \quad (3)$$

Where:

d is the damping ratio [-]

7.13 SoftRide and MLB

The SoftRide Isolation System is a spacecraft vibration and shock isolation system designed to reduce launch vehicle-induced loading on the spacecraft. SoftRide is a patented product of Moog CSA Engineering (www.csaengineering.com). It has been flown successfully at least 19 times, including 6 flights with MLBs (on the XSS-11, TacSat-2, -3, -4, IBEX, FalconSat-3, and GRAIL missions).

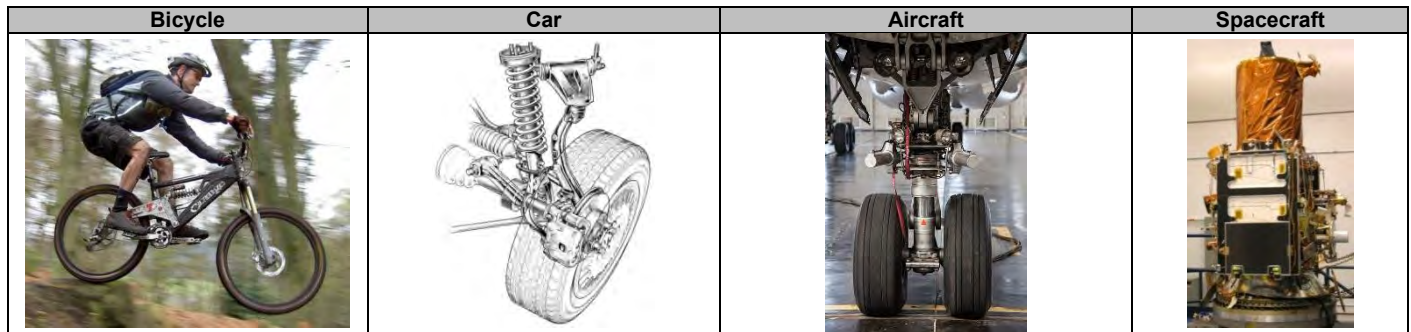

Table 7-7: Valuable payloads are isolated from detrimental external loading using spring-damper (isolation) systems

SoftRide Systems have several benefits when used in conjunction with the MLB:

1. Substantially reduce flight loads into the payload such as engine transients, random vibration, and shock.
2. Substantially reduce risk by isolating the payload from unanticipated launch load events.
3. Substantially increase damping. SoftRide damping ratio range is 3% to 25% depending on the needs of the mission.
4. Reduce stiffness requirements of the space vehicle because there is less value to a very stiff bus if it is sitting on a very flexible isolation system.
5. Reduce flatness requirements of adjoining vehicles because the isolation system is flexible.
6. Ease integration of the MLB by eliminating the need to stow the MLB to join the satellite to the launch vehicle. With the isolation system attached to the already stowed MLB, integration can occur by simply fastening the launch vehicle to the isolation system.

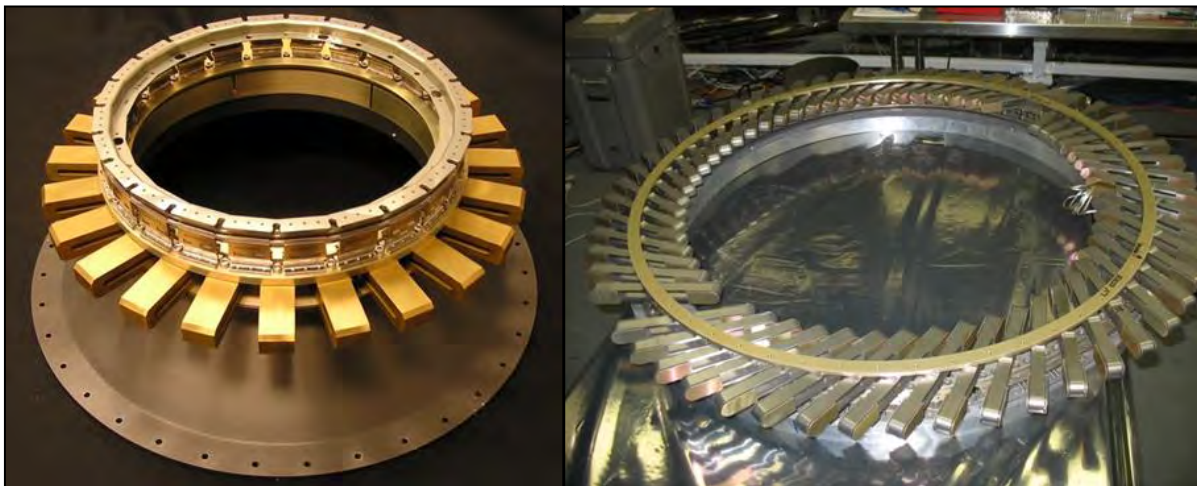

Figure 7-27: SoftRide used on an MLB15 and MLB38 inch MLB

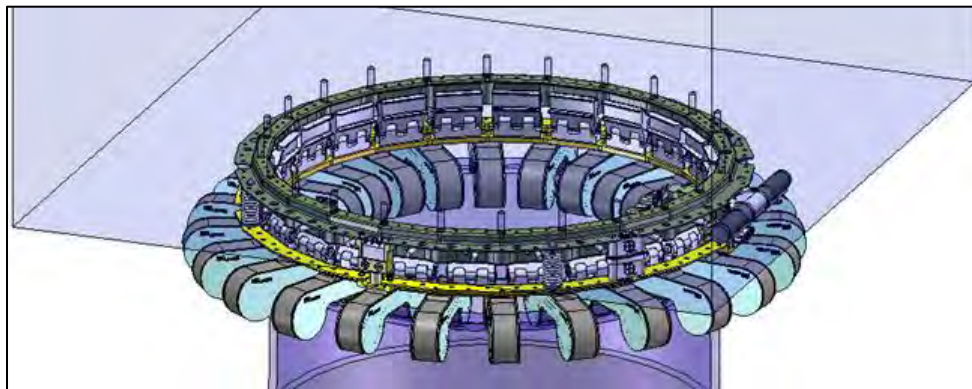

Figure 7-28: A rendering of CSA's SoftRide OmniFlex which isolates the satellite from the launch vehicle loads

Isolation systems add mass that is usually negligible compared to the spacecraft mass. In fact, the mass added by SoftRide is often nullified because the MLB has a lower mass than other separation systems. Isolation systems require a displacement stroke in order to attenuate dynamic loads. Typical axial strokes in-flight have been in the 0.2 to 0.4 inch range. Lower frequency, higher-performing isolation systems require more stroke than higher frequency isolation systems.

7.14 Fatigue Limits

Fatigue failure is generally defined as failure due to cyclic loading. Fatigue failure is typically manifested in a flight stack as a loss of preload in fasteners, a breakdown of surface treatments at separable interfaces, or cracking of materials. Fatigue can be induced by static loads, sine vibration, random vibration, and shock impulses. It can be locally amplified when dissimilar structures (ex. round to square) are joined to the MLB. The MLB's load limits are based on quasi-static strength testing. To derate for fatigue, see materials Table 7-8 for primary load path materials.

When derating the MLB's maximum load capability from Table 5-1 consider all loading events including mass loaded random vibration, sine sweep, sine burst and shock testing as well as flight environments. Also, given that most fatigue damage results from random vibration, there are often several combinations of loads and cycles. The customer shall use an equivalent fatigue damage approach to properly account for the combined effects of all loading.

7.15 Lifecycle & Refurbishment

The MLB can be cycled (stow, set-for-flight, & deploy) 60 times before inspection by PSC is required. This includes about 15-20 separation tests that PSC completes prior to shipping to the customer. Thus, the customer may typically separate the MLB about 40-45 times.

Stowing is more strenuous on the Motor Bracket Assembly than deploying. The motors consume about 20 Joules of electrical energy when stowing compared to about 2 Joules when deploying. After the 60th cycle, the MLB must be inspected by PSC Engineers to determine the wear rate and the amount of lubrication remaining. Using the minimum allowable voltages on all operations maximizes the MLB's cycle life. Lower voltages produce lower currents meaning stresses in the parts connected to the motors are minimized. In qualification and development testing, the MLB has been shown to reliably stow and deploy several hundred times while simultaneously being exposed to extreme temperature cycling.

After an MLB has been cycled 60 times, it must be inspected by PSC and considered for refurbishment. Prior to initiating refurbishment process, contact PSC for cost and schedule associated with the refurbishment service. Advance notice must be provided to PSC prior to returning MLB to PSC. The typical refurbishment process is as follows:

- 1) The MLB is shipped to PSC.
- 2) Provenance of the MLB is established. What handling/operation/testing occurred while outside PSC?
- 3) Analysis of handling and testing is performed to establish potential risks and problem areas. For instance, what line loading was experienced in test?
- 4) The MLB is inspected based on Step 3 results. This could be as simple as a visual examination or a complete tear-down and assessment. Only known non-destructive inspection techniques like dye penetrant analysis are performed.
- 5) A refurbishment plan for the unit based on Step 4 results is created. Examples range from simply re-greasing the Bevel Gears to replacing all components in the load path.
- 6) The refurbishment plan is executed.
- 7) A benchtop and environmental testing plan for the refurbished unit is determined. This could be all, none, or a selection of the acceptance tests defined in Section 16 of this document.
- 8) The environmental testing plan is executed.
- 9) The MLB is shipped back to the customer.

7.16 Alignment

Aligning Upper Ring & Lower Ring

Several features act sequentially to guarantee alignment of the Upper and Lower Ring prior to the stow event. In order of operation these features are:

1. The Separation Spring's conical tip mates with the Upper Ring's accepting holes. The telescoping features of the Separation Springs guide for about 0.6 inches of travel.
2. The cut-out for the Motor Bracket Assembly in the Upper Ring only allows one rotary orientation of the Upper Ring.
3. The polymer guide pins in the Separation Connector halves mate together.
4. The shells of the Separation Connector (if attached) align.
5. The shear pins of the Upper Ring and their accepting grooves in the Upper Link of the Leaves align together.
6. The Leaf lips align with their accepting grooves in the Upper Ring.

It is estimated that the variation in alignment in the above process is about 0.001 inch in any direction

Aligning with adjoining structures

The bolt patterns of the Upper and Lower Rings are concentric to within 0.01 inch when the MLB is stowed. The rotational tolerance of the Upper and Lower Ring is 0.1 degree when stowed.

Aligning the MLB to another structure can be accomplished by using flat head fasteners when the adjoining structure is threaded or gage pins when the adjoining structure has a flange with through holes. A flat head fastener has a conical feature that tends to force alignment. However, flat head fasteners should not be used to permanently fasten the MLB to an adjoining structure. A gage pin of 0.281 ± 0.005 inch diameter is the nominal diameter that would form a slip fit to the holes on the MLB.

7.17 Materials and Surface Treatments

Material surface treatments may be used to determine rates of radiative heat transfers and surface charging of the MLB and attached structures. All materials in the MLB are low out-gassing as defined by ASTM-E-595: total mass loss (TML) is less than 1.0% and collected volatile condensable materials (CVCM) is less than 0.1%. All of the materials in the primary load path are highly resistant to stress corrosion cracking (SCC) as defined by MSFC-STD-3029. See Table 7-8.

Item	Component Name	Material (1)	Surface Treatment (3, 4)	In Primary Load Path?	Highly Resistant to SCC (2)	Magnetic?	Vendor
1	Lower Ring	Al-Aly 7075-T7351 per AMS-QQ-A-250/12 or AMS 4078	Chem Conv, color gold, per Mil-DTL-5541, CI 3	Y	Y	N	PSC
2	Upper Ring	Al-Aly 7075-T7351 per AMS-QQ-A-250/12 or AMS 4078	Hard Anodize per Mil-A-8625, Type III, Class 1	Y	Y	N	PSC
3	Lower Hinged Link (of Hinged Leaf Assy)	Al-Aly 6061-T6 per AMS 4027	Electroless Nickel per ASTM B733, type IV	Y	Y	N	PSC
4	Upper Hinged Link (of Hinged Leaf Assy)	Al-Aly 6061-T6 per AMS-QQ-A-200/8 or AMS 4027	Electroless Nickel per ASTM B733, type IV	Y	Y	N	PSC
5	Pin (of Hinged Leaf Assy)	Al-Aly 6061-T6 per AMS 4115, 4116, 4117 or 4128	Electroless Nickel per ASTM B733, type IV	Y	Y	N	PSC
6	Leaf Retaining Ring	PH 15-7 Mo SST	-	N	-	Y	varies
7	Retaining Ring	Al-Aly 6061-T6 per AMS-QQ-A-250/11 or AMS 4027	Hard Anodize per Mil-A-8625 Type III, Class 1	N	-	N	PSC
8	MLB8 Retaining Ring	Al-Aly-7075-T7351 per AMS 4078	Hard Anodize per Mil-A-8625 Type III, Class 1	N	-	N	PSC
9	Motor Bracket	Al-Aly 6061-T6 per AMS-QQ-A-250/11	Hard Anodize per Mil-A-8625, Type III, Class 1	N	-	N	PSC
10	Sliding Tube	Al-Aly 7075-T7351 per AMS-QQ-A-250/12	Hard Anodize per Mil-A-8625, Type III, Class 1	N	-	N	PSC
11	Link Pin	A-286 per AMS 5732 or 5737	Passivate per AMS-QQ-P-35 Type II	N	-	N	PSC
12	Ball Screw & Nut	Alloy Steel, 17-4 PH SST, or 440C SST	-	N	-	Y	Proprietary
14	Motor Bevel Gear	300 SST	-	N	-	N	PSC
15	Screw Bevel Gear	464 Brass	-	N	-	N	PSC
16	Motor Support	Al-Aly 6061-T6 per AMS-QQ-A-250/11	Hard Anodize per Mil-A-8625, Type III, Class 1	N	-	N	PSC
17	Motor	Al, SST, Cu, Delrin, Neodymium	-	N	-	Y	Maxon
18	Spherical Plain Bearing	Carbon Chromium Steel	MoS2	N	-	Y	Proprietary
19	Link	Al 7075-T7351 per AMS-QQ-A-250/12	Chem Conv, color gold, per Mil-DTL-5541, CI 3	N	-	N	PSC
20	Link Retaining Ring	PH 15-7 Mo SST	-	N	-	Y	varies
21	Gear Cover	300 SST	-	N	-	N	PSC
22	Stow End Plate	Al-Aly 7075-T7351 per AMS-QQ-A-250/12	Chem Conv, color gold, per Mil-DTL-5541, CI 3	N	-	N	PSC
23	Deploy End Plate	Al-Aly 7075-T7351 per AMS-QQ-A-250/12	Chem Conv, color gold, per Mil-DTL-5541, CI 3	N	-	N	PSC
24	Limit Switches	Valox 420 Phenolic, SST, Silver, Diallyl Phthalate, Polyphenylene Sulfide, Polybutylene Terephthalate, Gold, Aluminum	-	N	-	N	varies
25	Link & Motor Bracket Plug	Viton Rubber	-	N	-	N	PSC
26	Linear Way & Rail	300, 400 & 440C SST	-	N	-	Y	Proprietary
27	Angular Contact Bearing	440C SST & Phenolic	-	N	-	Y	Proprietary
28	Assorted Shims	SST, Steel	-	N	-	Y	Proprietary
29	Wire	Cu coated Silver w/ ETFE	-	N	-	N	varies
30	Flex Circuit	Cu, Kapton, Pyralux	-	N	-	N	PSC
31	Solder	Sn60Pb40 or Sn63Pb37	-	N	-	N	varies
32	Heat Shrink Tubing	PVDF	-	N	-	N	varies
33	Spring Plunger	300 SST & Delrin	-	N	-	Y	Vlier
34	Ring Roller	Al-Aly 6061-T6 per various AMS specs	Hard Anodize per Mil-A-8625 Type III, Class 1	N	-	N	PSC
35	Leaf Shear Pin	18-8 SST	-	Y	Y	Y	Varies
36	Separation Spring	300 SST & Delrin	-	N	-	N	PSC
37	Separation Connector	Al-Aly 6061-T6 per AMS-QQ-A-250/11, VespeI SP-1, BeCu, brass, SST	Electroless Nickel per AMS-C-26074, Class 4, Grade B & gold	N	-	N	PSC
38	Separation Switch	Al-Aly, SST, Gold	Chem Conv, color gold, per Mil-DTL-5541, CI 3	N	-	N	PSC
39	Lightband Compression Tool Assy (LCT)	Al-Aly 7075-T73, Steel, 300 SST, A286, steel bearing, Arathane, Braycote 601EF	Chem Conv, color gold, per Mil-DTL-5541, CI 3	N	-	N	varies
40	Roller Restraint Pin	300 SST	-	N	-	N	PSC
41	Roller Compression Spring	300 SST or music wire	-	N	-	Y	Proprietary
42	Roller Spring Base	300 SST or A-286	Passivate per AMS-QQ-P-35 Type II or ASTM A967	N	-	N	PSC
43	Roller Spring Slider	300 SST or A-286	Passivate per AMS-QQ-P-35 Type II or ASTM A967	N	-	N	PSC
44	Leaf Fasteners	A-286	Passivate	Y	Y	N	varies
45	Assorted Fasteners	A-286, 300 SST, Alloy Steel	passivate, black oxide	N	-	Y	varies
46	9 Pin Connector	Bronze, Stainless, Glass Filled DAP, Gold	-	N	-	N	Positronic Ind.
47	Leaf Retaining Cord	302 SST per AMS 5688	-	N	-	N	PSC
48	Staking Compound	-	-	N	-	N	varies
49	Vacuum Grease	-	-	N	-	N	Castrol
50	Dry Lubricant	Molybdenum Disulfide Powder	-	N	-	N	varies
51	Serial Label	Polyimide with Solvent Acrylic Adhesive, Resin Ribbon	-	N	-	N	varies

(1) SST = stainless steel

(2) Per MSFC-STD-3029, only applies to parts in the primary load path

(3) Passivation specifications may be utilized interchangeably

(4) Mil-A-8625 may be interchanged with newer Mil-PRF-8625

Table 7-8: MLB materials and surface treatments

7.18 Part Marking

Each MLB is marked with its assembly number, serial number, and coordinate system on both Upper and Lower Rings. PSC does not provide customer-specified part marking, tagging, or bagging.

7.19 Subsystem Masses







Subsystem	PSC part number	Unit Mass [lb _m]	Remark	Graphic
Upper Separation Connector	4000107	0.025	The Upper Connector may be placed on either the Upper or the Lower Ring of the MLB. Includes mounting hardware. See PSC Document 2001025.	
Lower Separation Connector	4000106	0.025	See above.	
Separation Spring	4000307	0.032	Includes mounting hardware.	
Separation Switch main body	4000383	0.039	Includes mounting hardware. See PSC Document 2002204.	
Separation Switch bracket	4000383	0.006	The bracket reacts the force of the plunger. Includes mounting hardware.	
Lightband Compression Tool Assembly	4000637	0.010 (each, not per pair)	Suggested quantity is 1 pair per Separation Spring. Includes mounting hardware.	

Table 7-9: Subsystem masses

7.20 Component Spring Parameters

Several MLB subsystems contain springs that effect separation velocity. The values listed are the nominal stored energy, not the amount available to generate kinetic energy. Extensive testing has shown about 95 percent of the energy shown in the table below is available to create separation velocity. It is assumed that the remaining 5 percent is converted to heat from the effect of sliding friction during the separation event. See Section 7.22 for Separation Spring energy that manifests itself as velocity during separation.





Spring	Spring Constant [N/mm]	Stroke [mm]	Force Before Separation [N]	Force After Separation [N]	Stored Energy [J]	Remark	Graphic
Separation Spring	4.08	20.3	85.5	2.5	0.894	Used to create the separation velocity. Has telescoping features.	
Spring Plunger	11.4	3.18	48.8	12.8	0.06	These springs push the Leaves out of the Upper Ring. They do not influence separation velocity. One Spring Plunger is used per Leaf Assembly.	
Separation Connector	1.9	3.30	12.4	6.2	0.01 (total of all pins)	Data for mated pair. Each Connector has 15 pin contacts	
Separation Switch	3.3	3.84	16.5	3.9	0.02	Each Switch houses one plunger.	

Table 7-10: Spring parameters

7.21 Rotation Rates

Rotation rates are induced by the distance between the payload's center of mass (CM) and the center of the MLB's spring force. Rotation rates may be about any axis of a space vehicle as a result of the separation event.

Rotation rates can be estimated via Equation (4). There are many variables that contribute to this rate and several simplifying assumptions have been made to compensate. Equation (4) assumes the adjoining vehicle is many times more massive (>10X) and has many times more inertia (>10x) than the separating vehicle. It also assumes the pre-separation rates are all zero. Only Separation Reliability testing can produce verifiable values for rotation rates. See Section 16.2.1.

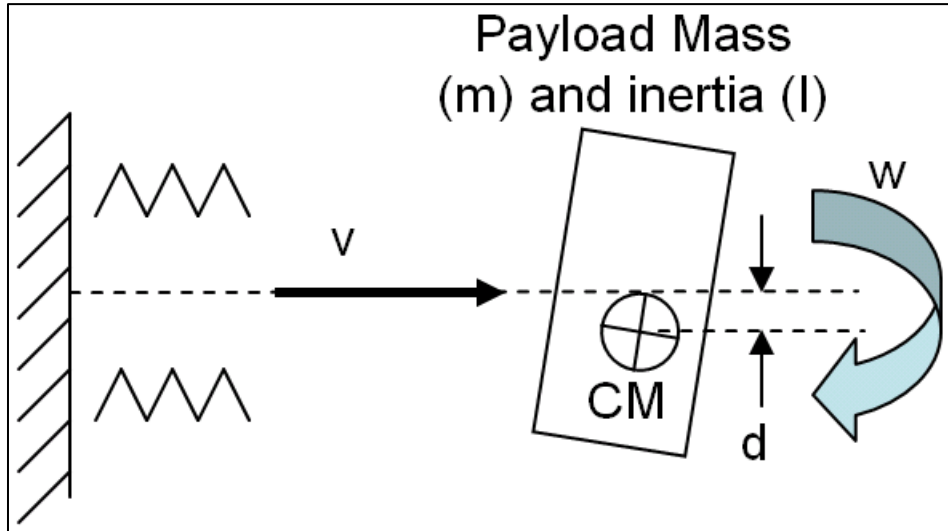

Figure 7-29: CM offset and rotation rate

$$w = \frac{mvd}{I} \tag{4}$$

Where:

w is the payload rotation rate [rad/s]

m is the mass of the payload [mass]

v is the relative velocity [length/s]

d is the distance between the CM and the resultant location of the Separation Springs [length]

I is the mass moment of inertia about the center of mass of the separating vehicle [mass·length²]

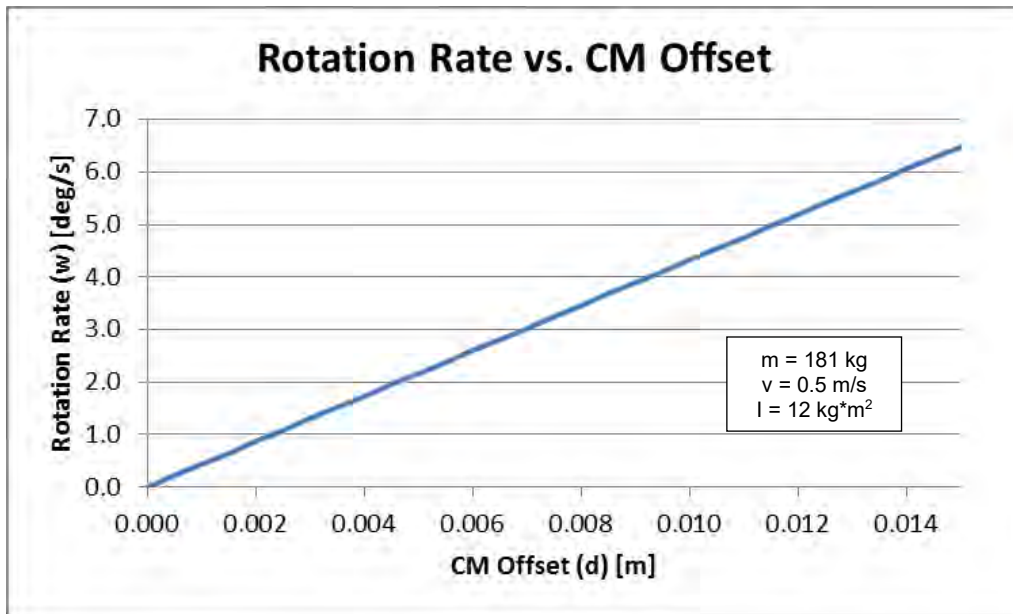

Figure 7-30: An illustration of Equation 4

The Separation Spring configuration may be adjusted on the MLB so the Springs, as a sum, act through the CM. This will require custom testing. Instead, it may be easier to move the CM. The lower the v required, the lower the rotation rates of the payload.

Sometimes rotation rates are desired as this may beneficially produce even solar heating, dynamically stabilize the vehicle, or counter pre-separation rates. In such cases, relocating the Separation Springs to one side of the CM or creating a CM offset (d) affects the desired rotation rates.

7.22 Separation Velocity, and Separation Springs

Equation (5) is used to calculate the required total separating energy, **E**, given a desired velocity between the payload and final stage.

$$E = \frac{(mM)v^2}{2(m + M)} \quad (5)$$

Equation (6) is used to calculate the estimated number of Separation Springs, **S**, required given a desired velocity between the payload and the final stage.

$$S = \frac{mM}{m + M} \times \frac{v^2}{2e} \quad (6)$$

Equation (7) is used to calculate relative velocity, **v**, between payload and final stage given a known total stored energy.

$$v = \sqrt{\left(\frac{2E(m + M)}{mM}\right)} \quad (7)$$

Where:

m is the payload mass [kg] (Includes mass of MLB Upper Ring)

M is the final stage mass [kg] (Includes mass of MLB Lower Ring. Excludes payload mass)

v is the relative velocity between **m** and **M** [m/s] (ΔV or separating velocity)

S is the number of Separation Springs [-] (even qty. preferred)

e = 0.85 J is the approximate stored potential energy of a single Separation Spring that is converted to kinetic energy manifested as **v**. It includes efficiency losses.

E = S • e is the total MLB separating energy manifested as **v** [J] (The stored potential energy of all Separation Springs that is converted to kinetic energy. It includes efficiency losses. See Table 5-1 for typical ranges for each MLB size.)

Example 1: velocity is known, total separating energy is desired

Payload mass, $m = 200$ kg

Final stage mass, $M = 3000$ kg

Desired relative velocity, $v = 0.356$ m/s

$$\text{Total Separating Energy, } E = \frac{(200 \text{ kg} * 3000 \text{ kg}) * (0.356 \frac{\text{m}}{\text{s}})^2}{2 * (200 \text{ kg} + 3000 \text{ kg})} = 11.9 \text{ J}$$

Example 2: total separating energy is known, required number of Separation Springs is desired

Total separating energy, $E = 11.9$ J

$$\text{Number of Separation Springs, } S = \frac{11.9 \text{ J}}{0.85 \frac{\text{J}}{\text{Spring}}} = 14 \text{ Springs}$$

Example 3: Total separating energy is known, relative velocity is desired

Payload mass, $m = 200$ kg

Final stage mass, $M = 3000$ kg

Total separating energy, $E = 11.9$ J

$$\text{Relative velocity, } v = \sqrt{\left(2 * 11.9 \text{ J} * \frac{200 \text{ kg} + 3000 \text{ kg}}{200 \text{ kg} * 3000 \text{ kg}}\right)} = 0.356 \frac{\text{m}}{\text{s}}$$

Observe that the quantity and mass of Separation Springs increases with the square of **v**. A small increase in velocity requires a significant increase in Springs. This increases the force required to compress the MLB and can complicate integration. The allowable quantity of Separation Springs varies by MLB diameter. See Table 5-1.

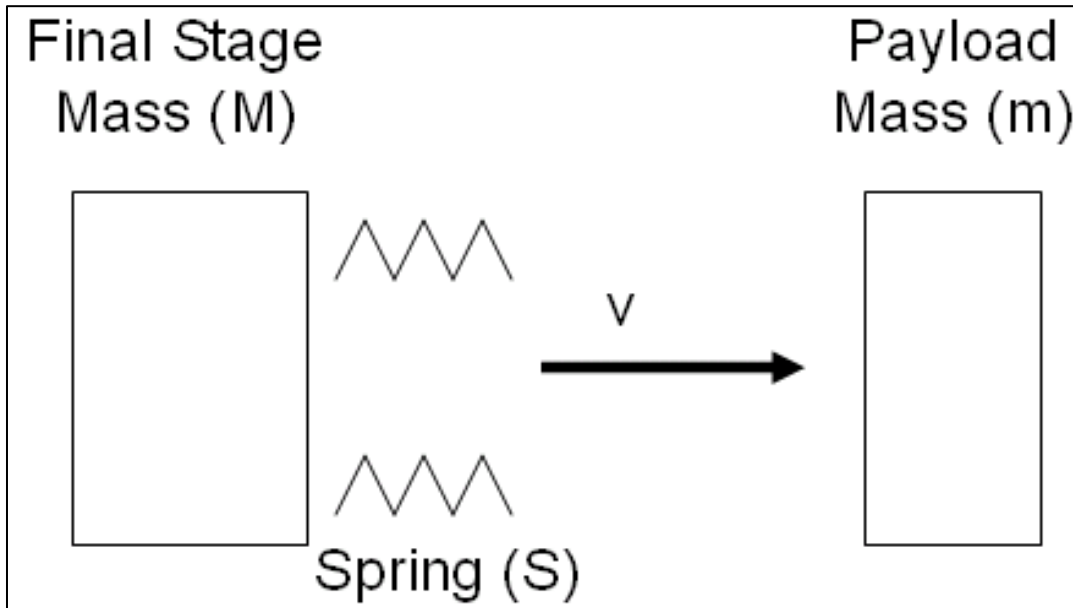

Figure 7-31: The relative velocity (v) is created by the Separation Springs (S)

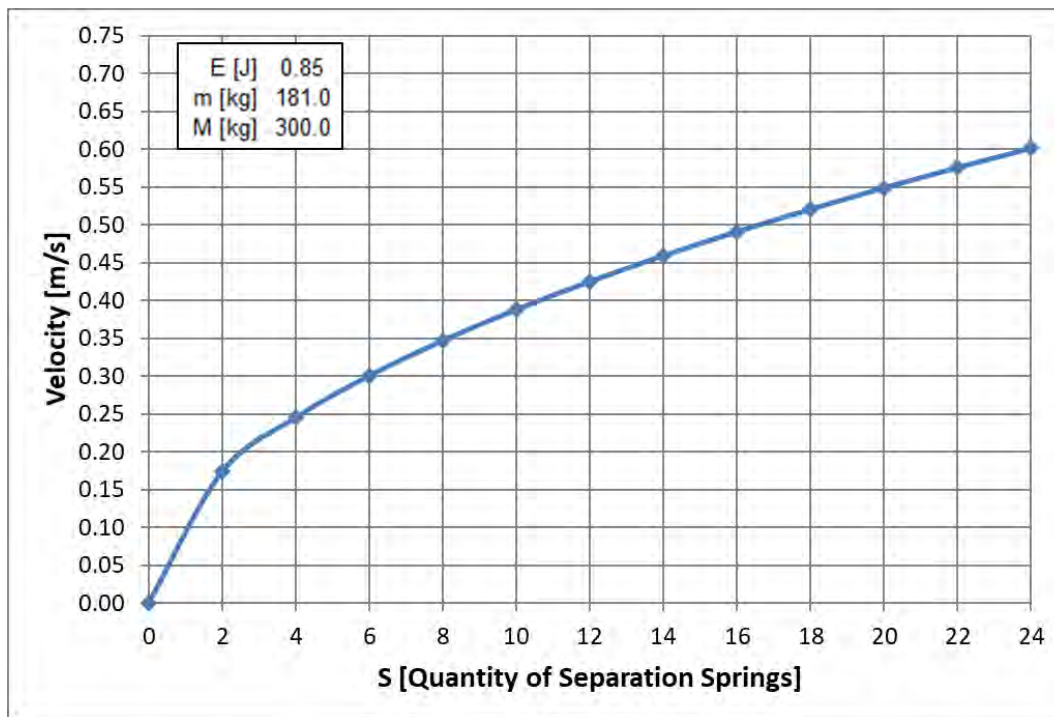

Figure 7-32: Spring quantity required increases with the square of velocity

The location of Separation Springs, Connectors, and Switches need not be symmetric to minimize rotation rates. Sometimes PSC engineers will modify the location (configuration) of Separation Springs to null out rotation rate torques during Separation Reliability tests. This tuning process is done when flight hardware is acceptance tested. See Section 16.2.1.

When several payloads are on the same launch vehicle, engineers can minimize the possibility of re-contact by varying the separation velocity and direction. Angling the payloads so they push through the center of mass reduces rotation rate torques and the possibility of re-contact. See Figure 7-33.

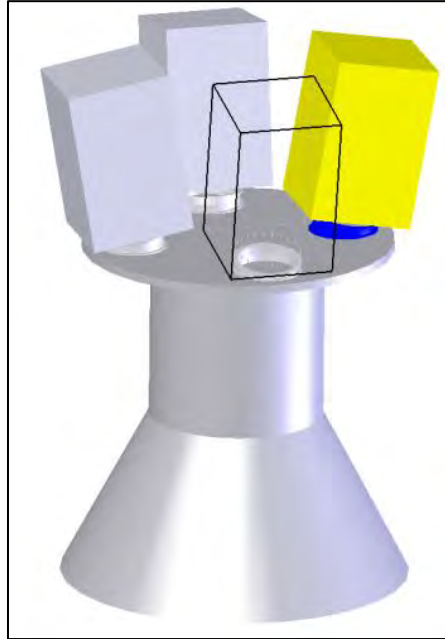

Figure 7-33: Simulated view of several payloads on the same launch vehicle

8. Electrical Properties

See PSC document 2000781 MkII MLB Operating Procedure for proper electrical connections to operate an MLB.

8.1 Schematics

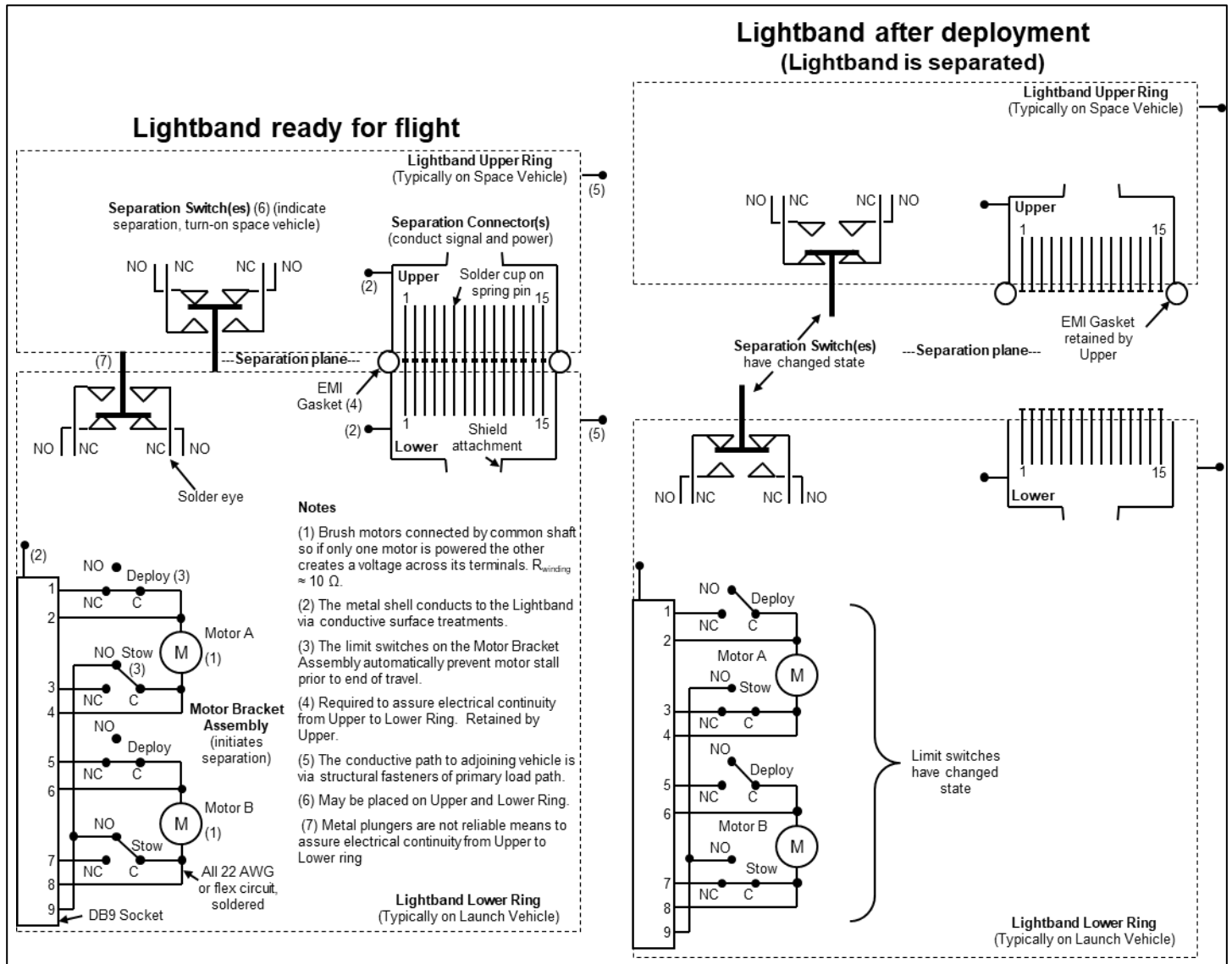

Figure 8-1: MLB Schematic³

³ The DB-9 connector and the motor cases are electrically grounded to the Lower Ring.

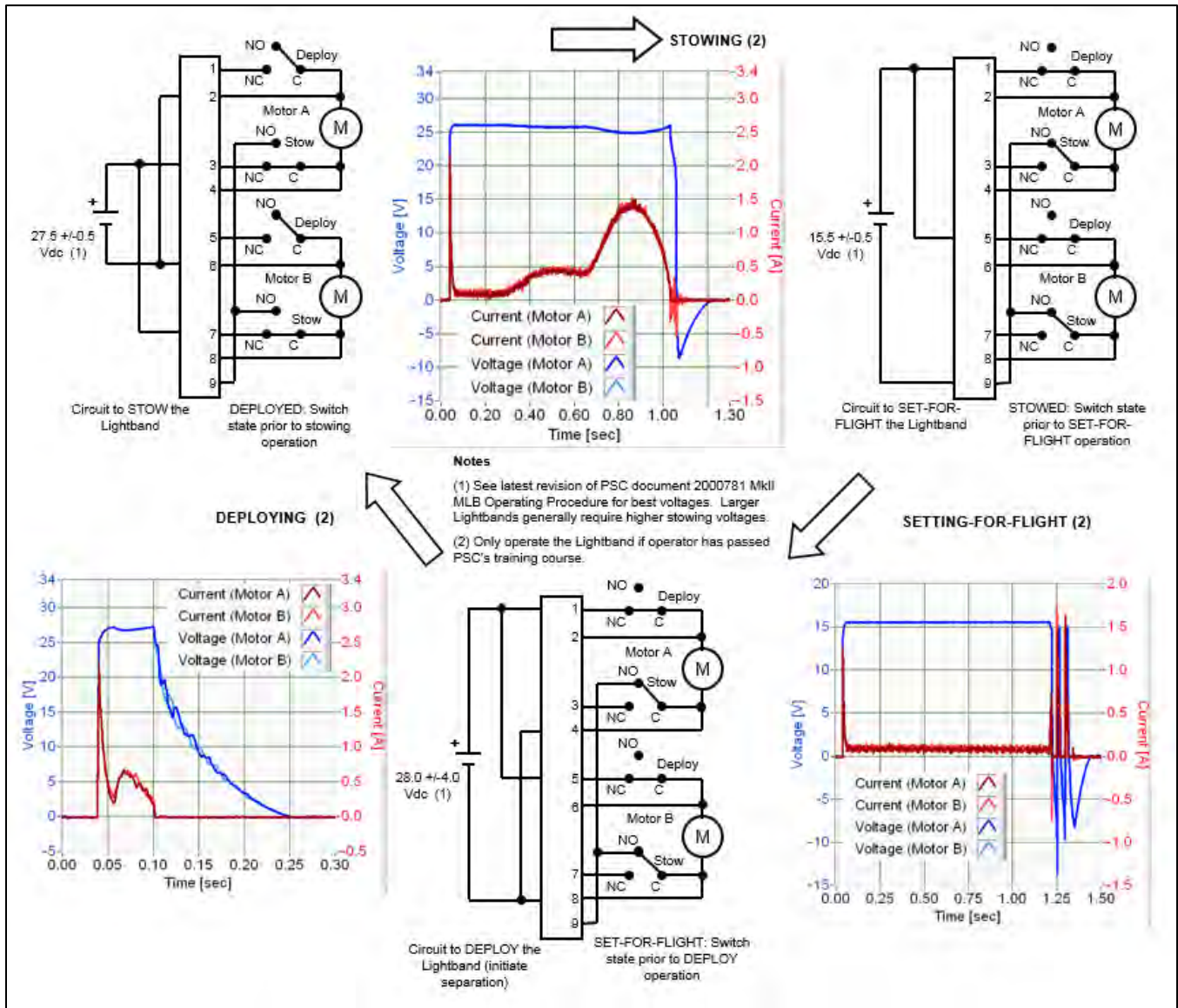

Figure 8-2: Schematics to stow, set-for-flight and deploy

8.2 The Motor Bracket Assembly

The Motor Bracket Assembly is the initiator of the MLB. Providing it with sufficient power will cause separation of the MLB when the MLB is stowed. The DB-9 socket connector is permanently fastened to the Motor Bracket Assembly.

The Motors are DC brush (precious metal commutation). They contain permanent magnets. The manufacturer is Maxon Motors US and the stock part number is RE16-118686. A version of this motor is used to operate the Martian Rover "Sojourner".

The Motors are physically connected to each other via bevel gears. Both should be simultaneously powered to induce MLB separation. However, one motor alone will power the MLB to cause separation as a redundancy mechanism.

Stowing the MLB shall only be performed by powering both Motors because the stowing process requires more power than a single Motor can provide. Beneficially, if the MLB can't be stowed, this indicates a fault in the Motor Bracket Assembly. If it can be stowed, this indicates the Motor Bracket Assembly is functional.

Maximum reliability of the MLB can be attained by minimizing the power into the MLB and the number of cycles. Specifically, avoid unnecessary stow and deploy operations and minimize specified voltage levels. Higher voltages will put more power into the mechanism. More power leads to higher current which leads to higher torque which leads to higher stresses in the Motor Bracket Assembly.

8.3 Wiring Harness Design

In the beginning of programs, engineers and program managers often underestimate the cost, weight, and size of wiring harnesses. This is due in part to the difficulty of modeling a harness using CAD software. Harnesses sometimes cost and weigh more than the MLB. Additionally, poorly-designed harnesses can obstruct access to the MLB fasteners. If the net shape of the harness is not predetermined, it may not fit and will require extensive re-work. As such it is **absolutely essential** to complete a detailed CAD model of the wiring harness. PSC does not supply harnesses from the MLB or through the MLB. PSC recommends the simplest possible harness design using the smallest quantity of Separation Connectors and Switches.

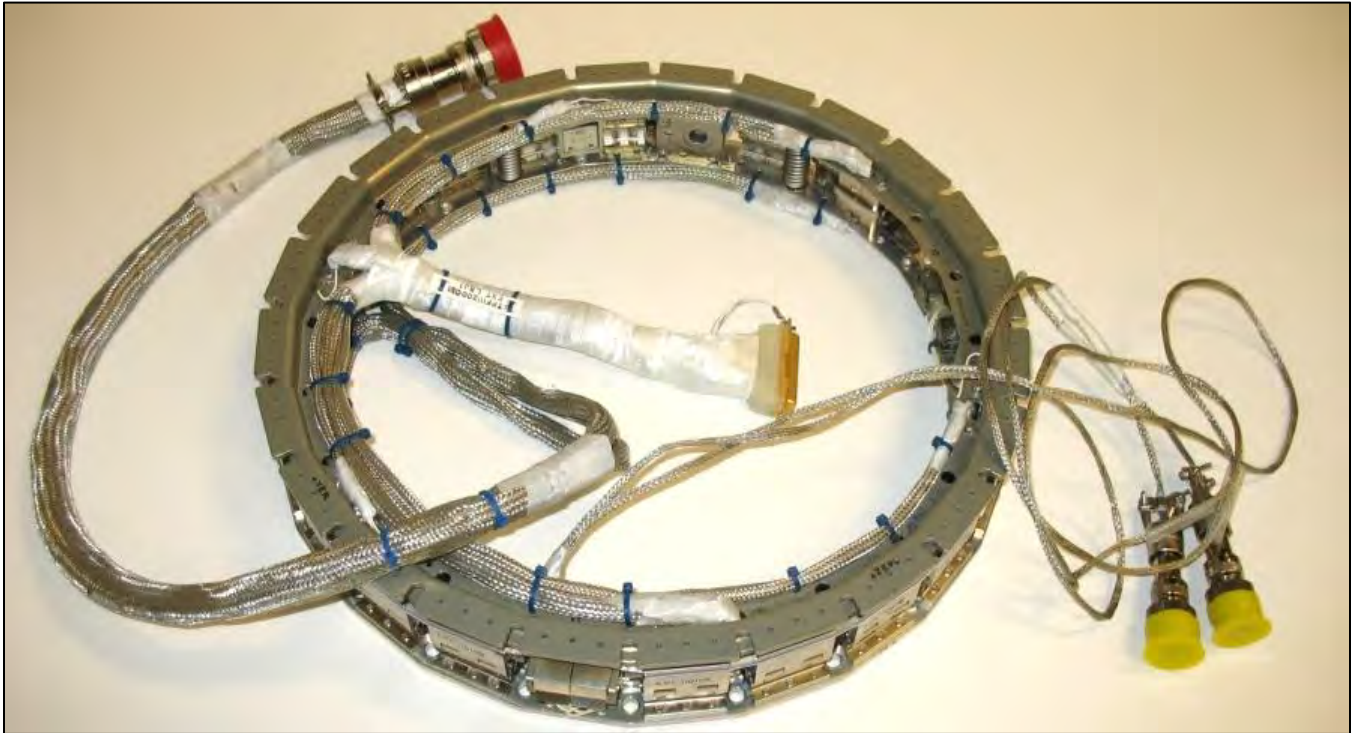

Figure 8-3: A fully featured 3.0 lb. harness on a 5.2 lb. separation system

Users should anticipate the process of attaching the harness to the halves of the MLB and the adjoining vehicles. The harness can be attached or removed from the MLB in both the stowed and deployed states. The Separation Connectors and Switches are designed to be attached to the MLB from the outside of the ring while deployed, but can also be installed when stowed. While the harness can be passed through the Leaves in the Lower Ring assembly of the MLB, doing so creates a substantial mechanical integration difficulty. Getting tools at the fasteners to adjoining vehicles becomes difficult or impossible. Internal harnesses should be avoided because of this access issue.

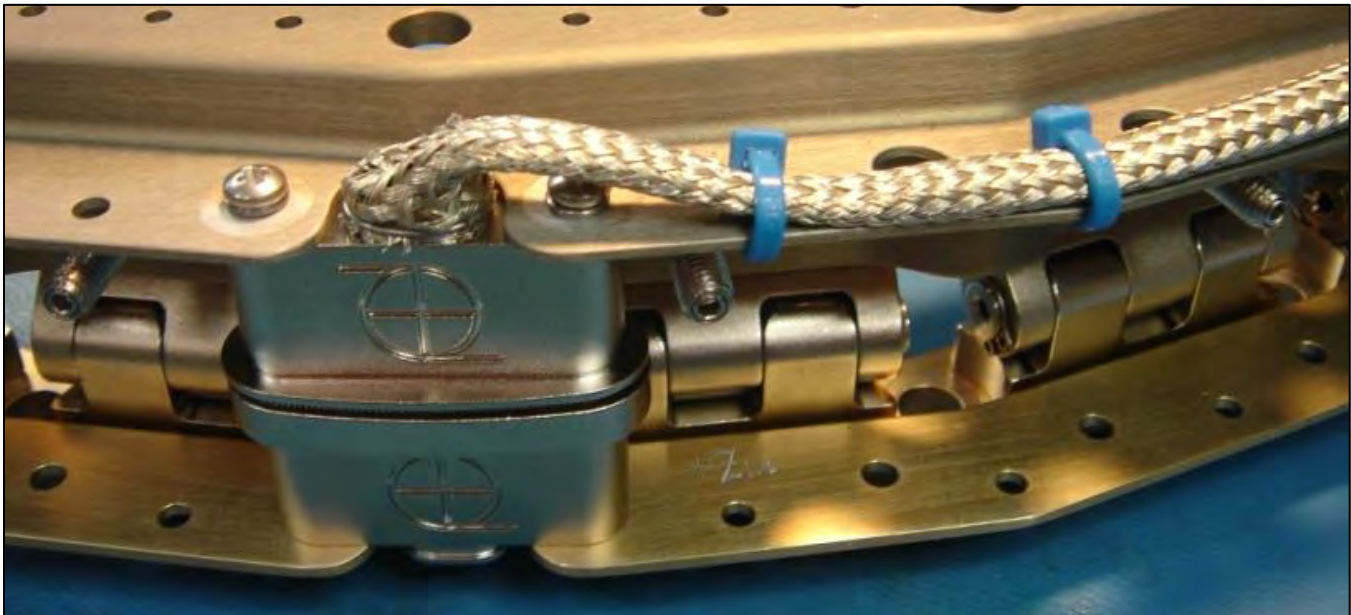

Figure 8-4: Through-holes on the outer lip of the MLB Upper and Lower Ring exist for routing tie wraps to support harnesses

8.4 Separation Electrical Connectors

The Separation Connector designed by PSC exhibits essentially zero friction during separation so as to ensure low rotation rates. Most electrical connectors are designed to stay together - an attribute separation systems must avoid! A full description of PSC's Separation Connectors can be found in PSC Document 2001025 Separation Connector Data Sheet.

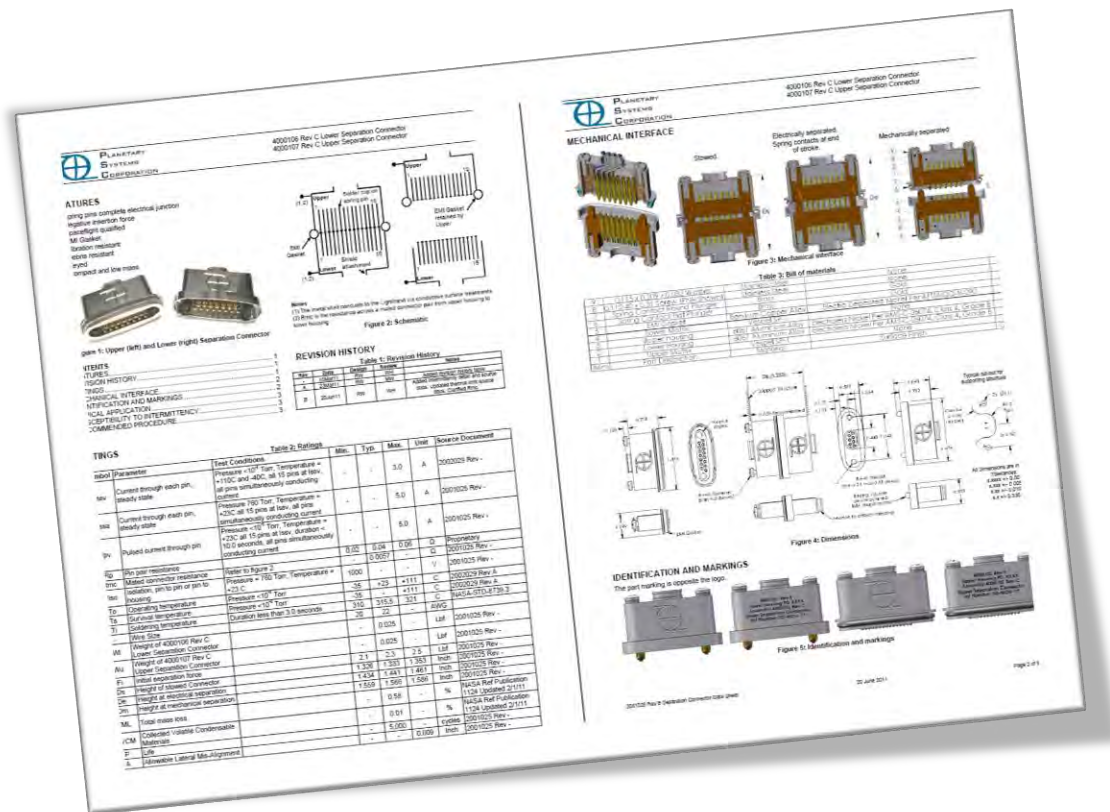

Figure 8-5: Separation Connector as described in PSC Document 2001025 Separation Connector Data Sheet

The connectors have been extensively tested in shock, vibration, and thermal vacuum environments. Product benefits include:

- Prevents incorrect MLB alignment via a keying feature.
- Separates in parallel with the MLB to ensure minimal induced rotation.
- Can ship ahead of the MLB and allow the harness to be manufactured concurrently by the customer. In such a case, the harness may be attached to the MLB whenever convenient for the customer. The Connectors can also ship with the MLB if desired by the customer.
- May be installed on the MLB before or after stowing.

PSC Separation Connectors can be used as electrical loop-backs. The multiple pins allow for a more mass efficient means of indicating separation compared to a Separation Switch. The Separation Connector pins can have intermittent connectivity during very high shock and vibration so employing redundancy and de-bounce into the circuits is recommended to alleviate this concern. Figure 8-6 shows 3 pairs of pins wired in parallel as redundant loopbacks to indicate separation for both the payload and launch vehicle.

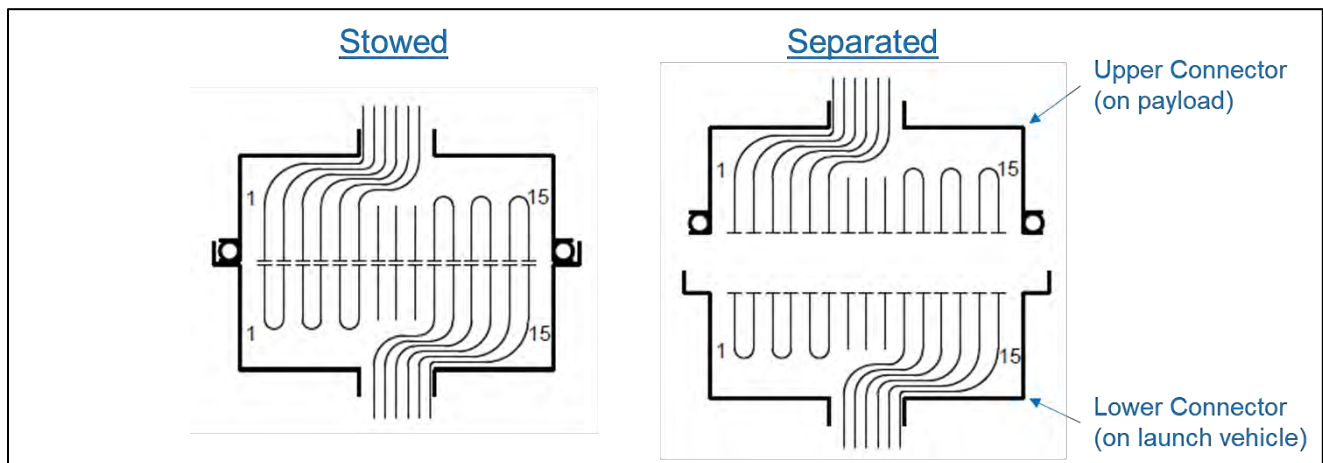

Figure 8-6: Separation Connector used as loopback

8.6 Operation Electrical Parameters

Allowable electrical parameters and schematics for all three MLB operations can be found in the latest version of PSC Document *2000781 MkII MLB Operating Procedure* which is available for download on PSC's website.

Skipping the set-for-flight operation and deploying the MLB from a stowed state is not permitted by *2000781 MkII MLB Operating Procedure*. If the set-for-flight operation is skipped, the MLB will require approximately 0.65 seconds to initiate. Additionally, the time to initiate will be less consistent over multiple deployments without a set-for-flight operation. Set-for-flight also verifies torque margin and proper MLB operation.

Along with initiating separation, motors are also outstanding transducers that provide great insight into the state of the MLB. Power (voltage multiplied by current), energy (integral of power) and torque (torque constant multiplied by current) can easily be calculated via motor response data. When necessary, this gives engineers a thorough understanding of MLB performance.

Note Regarding Current Values

The first peak current parameter defined in 2000781 occurs when a motor is turned on. First peak current is calculated via Equation (8) (Ohm's Law) When the motor is turned on, the current rises to V/R for no more than 0.02 seconds. The nominal winding resistance of the Motors is 10.3Ω . However, resistance varies with temperature in accordance with Equation (9)⁴. The tolerance on Equation (9) is $\pm 10\%$ due to motor manufacturing variations.

$$I = \frac{V}{R} \quad (8)$$

Where:

I is current [A]

V is voltage [V]

R is motor winding resistance [Ω]

$$R = 10.3(1 + 0.0039(T - 25)) \quad (9)$$

Where:

T is motor winding temperature [$^{\circ}\text{C}$]

⁴ Source: Manufacturer specifications

8.7 Separation Parameter Variation

The following figures are used to illustrate how an MLB's time to initiate varies with both voltage and temperature. Furthermore, Figure 8-8 shows the time to initiate with only one of the two motors receiving power, which verifies >100% torque margin under worst-case environmental conditions. Not only is only one motor powered, but the powered motor must also generate additional torque to back-drive the unpowered motor, gearhead and common bevel gear. In practice per the MKII MLB Operating Procedure, both shall be used for initiation.

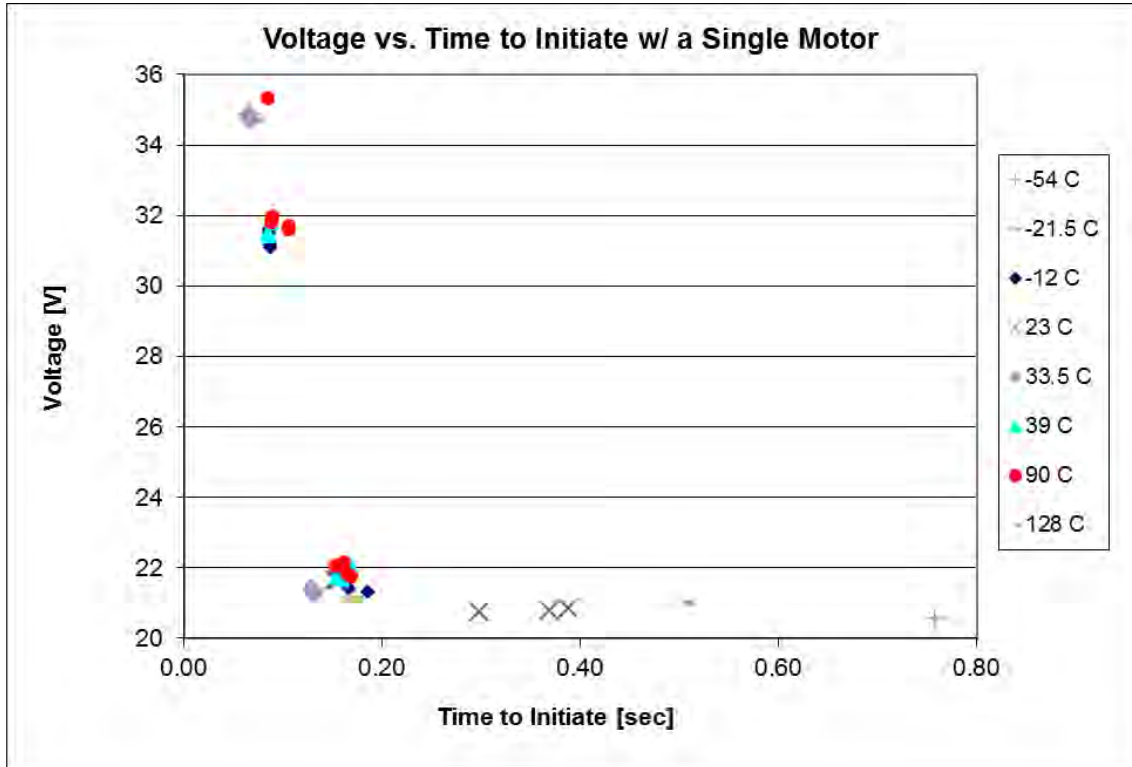

Figure 8-8: Voltage vs. time to initiate at various temperatures with a single Motor only at $\leq 10^{-5}$ Torr

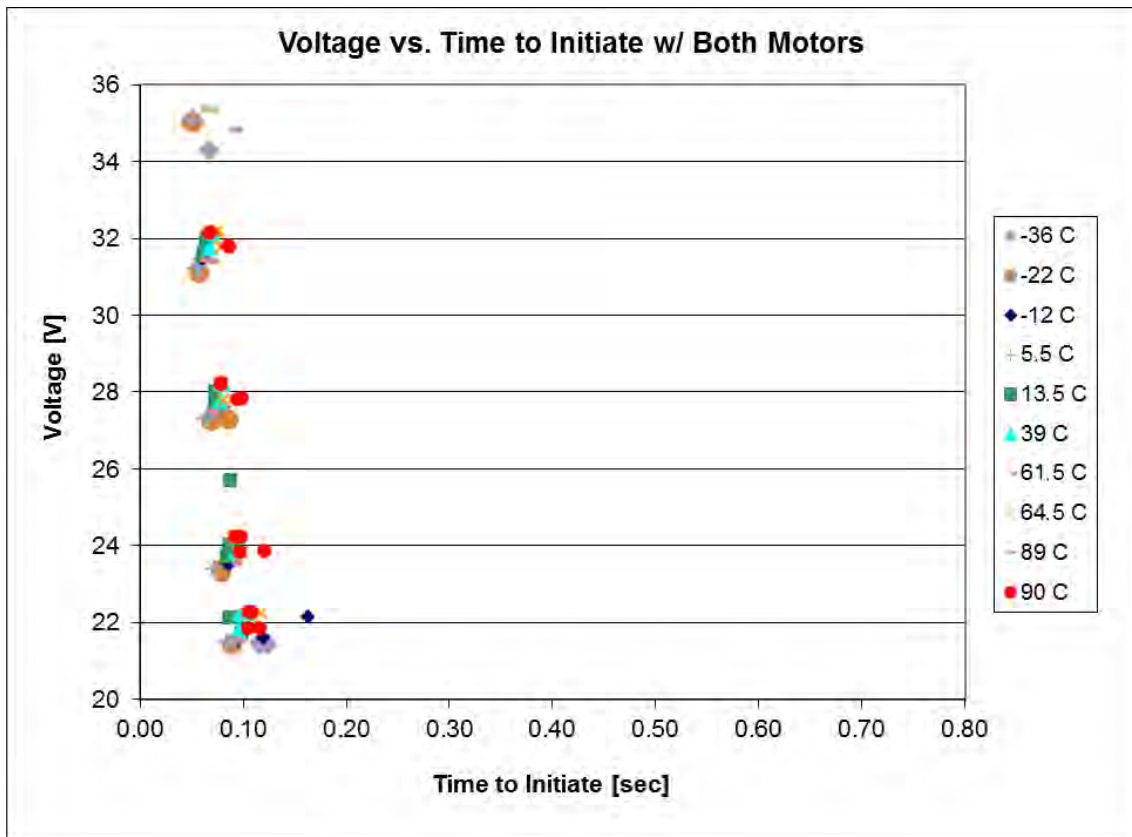

Figure 8-9: Voltage vs. time to initiate at all temperatures with both motors at $\leq 10^{-5}$ Torr

8.8 Shorted Motors

When one of the Motors is shorted, the shorted Motor will act as a damper consuming most of the energy that the other Motor generates. The time-to-initiate will increase significantly. Do not short the motor(s)! Figure 8-10 shows the difference in time to initiate when a Motor is open versus shorted. An increase in time to initiate is clearly apparent at multiple temperatures.

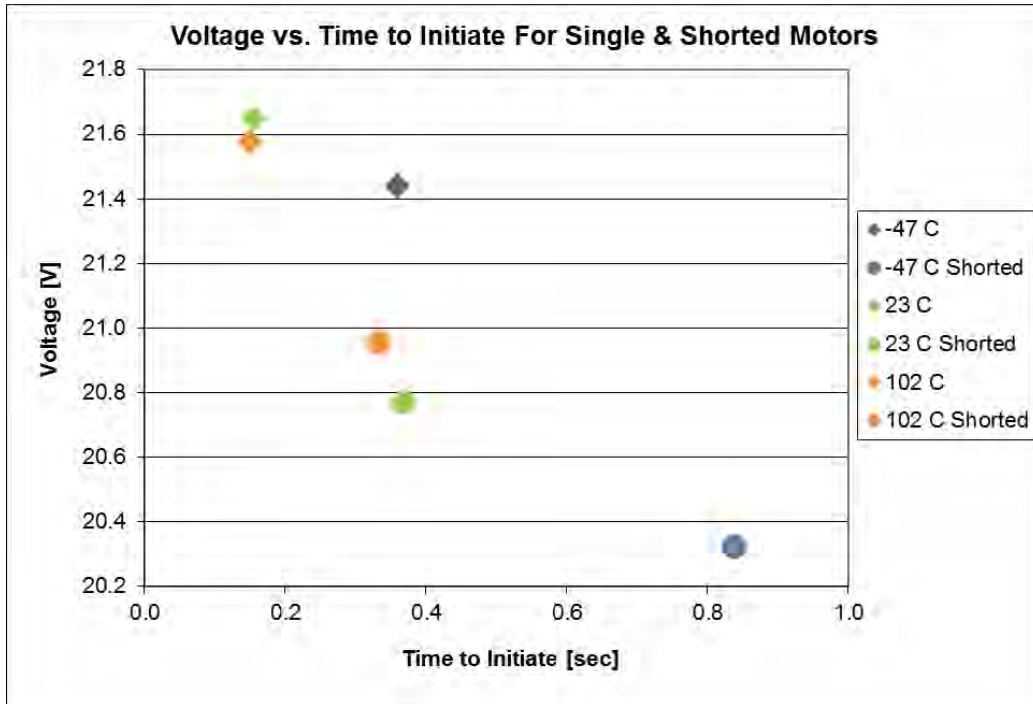

Figure 8-10: Voltage vs. time to initiate at various temperatures with a single Motor or a single shorted Motor at $\leq 10^{-5}$ Torr

8.9 Back EMF of the Motors

The Motors are connected to each other via bevel gears. Motors behave like direct current generators while running. If only one Motor is powered, the other will generate a voltage almost as high as the voltage of the powered motor, but with zero current. The unpowered voltage is proportional to rotational speed.

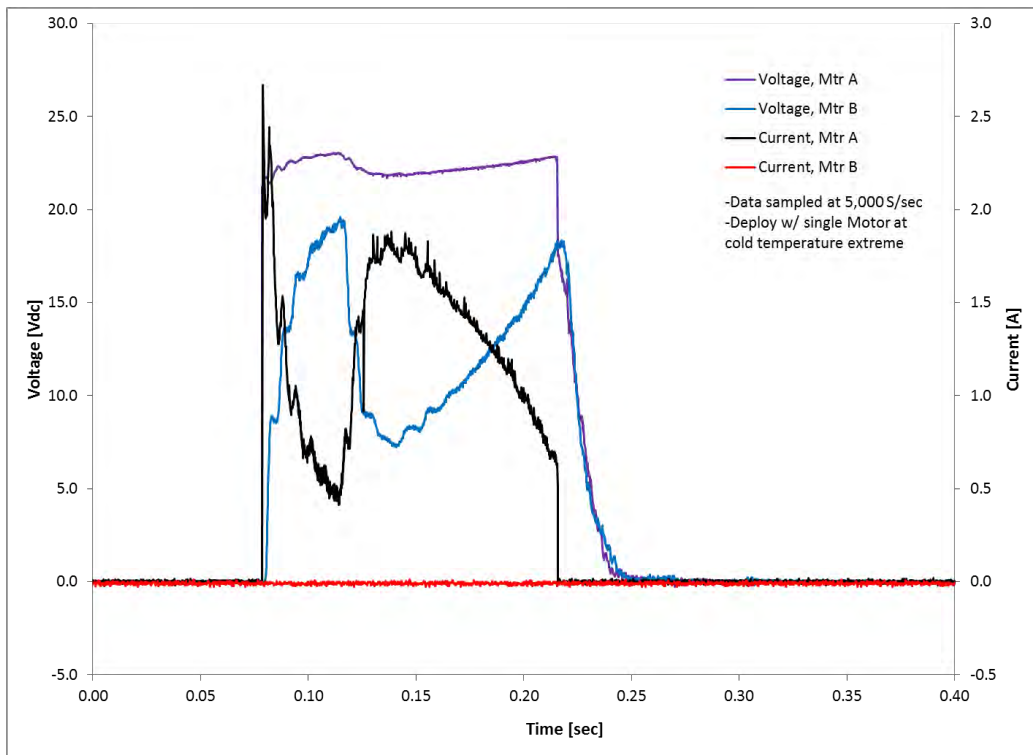

Figure 8-11: Only Motor A is powered, and thus Motor B indicates a voltage but not a current

8.10 Electrical Resistance

The resistance from the upper surface of the Upper Ring to the lower surface of the Lower Ring of the MLB is dependent upon the inclusion of a Separation Connector. If electrical grounding to the MLB is desired, the Separation Connector (in-flight disconnect) must be installed. At least one Separation Connector is required to ensure conductivity because the Upper Ring is anodized. The conductive path is through the Separation Connector shells and EMI gaskets in the Separation Connector Assemblies. Grounding to adjoining structures is achieved by using conductive fasteners from the MLB to adjoining structures. The conductive shell of the DB-9 connector is fastened mechanically and electrically to the lower assembly of the MLB.

See 2001025 Separation Connector Data Sheet for electrical resistance range.

8.11 Surface Charging

Because the Upper Ring has an anodized surface, it may be susceptible to localized surface charging. It is grounded to adjoining structures at each attachment bolt location (about every two inches along its circumference). The shells of the Separation Connectors are grounded at their mechanical interface to the Upper Ring via a local spot face where the anodized surface is removed. The Lower Ring is not anodized and its surface is fully conductive.

8.12 Radiation Sensitivity

The MLB is not sensitive to radiation. The MLB does not possess any integrated circuits or semi-conductors. There are no diodes, capacitors or resistors.

8.13 Static Sensitivity

The MLB has no static-sensitive parts.

9. Thermal Properties

9.1 Value of Motors in Extreme Thermal Environments

The MLB motors are DC brush motors. The brushes are made of a precious metal and not graphite (graphite should not be used in a vacuum because its performance degrades rapidly without water vapor). Extensive thermal-vacuum testing demonstrates the motors are not susceptible to failure when used in the MLB as a separation system.

The most extreme thermal environment for an MLB was STS-116 (Dec. 9th through 22nd, 2006). Three MLBs were used on the CAPE-ICU-I mission. ICU separated from the Shuttle on the 13th day of the mission. By then the 3 MLBs had been exposed to approximately 250 (-25 to +70°C) thermal cycles. The temperature at separation was estimated to be -40°C. On STS-127 (July 2009), CAPE-ICU-II performed the same mission with 3 additional MLB separations.



Figure 9-1: Three MLBs used on STS-116

Generally, the thermal environment of unmanned missions is more benign than shuttle missions because the separation event on unmanned missions usually occurs within minutes of reaching orbit and because high-value spacecraft and the final stages of their launch vehicles go to substantial lengths to avoid temperature extremes.

All flight MLBs are tested in a thermal-vacuum environment at PSC. The standard thermal vacuum test is shown in Section 16.1.2.

9.2 Survival and Operating limits

See Table 5-1 for survival and operating temperature limits.

Extensive testing has shown the ideal operating temperature is +35°C. This temperature minimizes time and energy required to initiate. At lower temperatures the energy and time to initiate increase because of the greater viscosity of lubricants and CTE mismatches of the components. As such, cold temperatures result in an increase preload of dynamic mechanized junctions. However, the motor's winding resistance decreases at lower temperatures allowing more current to flow to the motor and thus more torque to drive the initiation.

Non-operational survival temperatures include the range that an MLB has been exposed to in thermal vacuum testing while unpowered in a set-for-flight state, followed by nominal performance once returned to the typical operation temperature range. Operational limits are 10°C less extreme than temperatures at which a unit successfully operated during testing. Units are acceptance tested per Section 16.1.2.

9.3 Absorptivity and Emissivity

The materials in Table 7-8 show the surface treatments of the MLB components. They may not be modified by the addition of paint or tape because there is no area to apply such treatments. Specific measurements of thermal optical absorptivity and emissivity of the MLB have not been performed by PSC as they are highly dependent upon variations in surface treatment. For the clear hard anodize of the MLB Upper Ring, PSC defers to industry accepted range for these values given in multiple sources⁵. See Table 5-1 for solar absorptivity and emissivity values. A few customers have performed testing of samples, hence the wide range shown.

Customers occasionally ask about modifying the surface treatment of the Upper Ring to obtain desired thermal properties. The discussion below details why this is not feasible.

The anodized surface treatment is necessary because its hardness greatly reduces wear in repeated use. Alodine or raw aluminum would wear rapidly and potentially cold weld or stick, preventing separation. Hard surfaces enable reliable mechanisms.

The Upper Ring is peppered with several types of holes, cut-outs and engravings to interface to Separation Connectors, Switches, LCTs, Springs, Leaves, tie-wraps and bolts. Many of these features would have to be masked to avoid isolating the parts or to prevent the introduction of a soft material that would wear, stick or produce Foreign Object Debris (FOD). (Terrestrial example of the same concern: a common problem in house renovation is when the painters paint the door latch or windows shut.)

The many through-holes allow solar energy and infrared emission to pass through the MLB reducing the surface area of the Upper Ring.

Any custom surface treatment would require much stricter handling since the oils from hands and debris can either oxidize surface treatments (like nickel plating) or add an opaque layer in the non-visible spectrum. This can be problematic since grease applied at the Leaf lip junction can easily migrate when handled even with nitrile gloves.

It may be effective to employ insulative washers between the Upper Ring and the spacecraft. Titanium, stainless steel, FR-4 and Ultem have been successfully used to thermally isolate structures. The TSX-5 program employed Ultem washers for exactly this purpose.

⁵ Source: Appendix A of Spacecraft Thermal Control Handbook Volume 1, Edited by Gilmore

9.4 Thermal Resistance

The thermal resistances of the MLB vary by diameter as shown in Table 5-1.

9.5 Nominal Thermal Response

The MLB is intimately connected to massive adjoining structures on orbit. Typically, its view factor to Earth, space, or the Sun is low due to the density and size of adjoining structures. As such, the MLB temperature is primarily driven by conduction to and from adjoining vehicles. Adjoining space vehicles usually cannot tolerate temperatures outside of a 0 to +56°C band because these temperatures often exceed operating limits of propellants, electronics, and batteries which operate inside these vehicles.

9.6 Thermal Gradients and Transients

The MLB has been separated while exposed to a substantial temperature differential between the Upper and Lower Rings. The figure below details the results of a test where 900 W was applied to the Lower Ring (emulating heating from a rocket motor) for 188 seconds preceding a separation at 10^{-5} Torr. The temperature difference between the Upper and Lower Rings of the MLB was 30°C at separation.

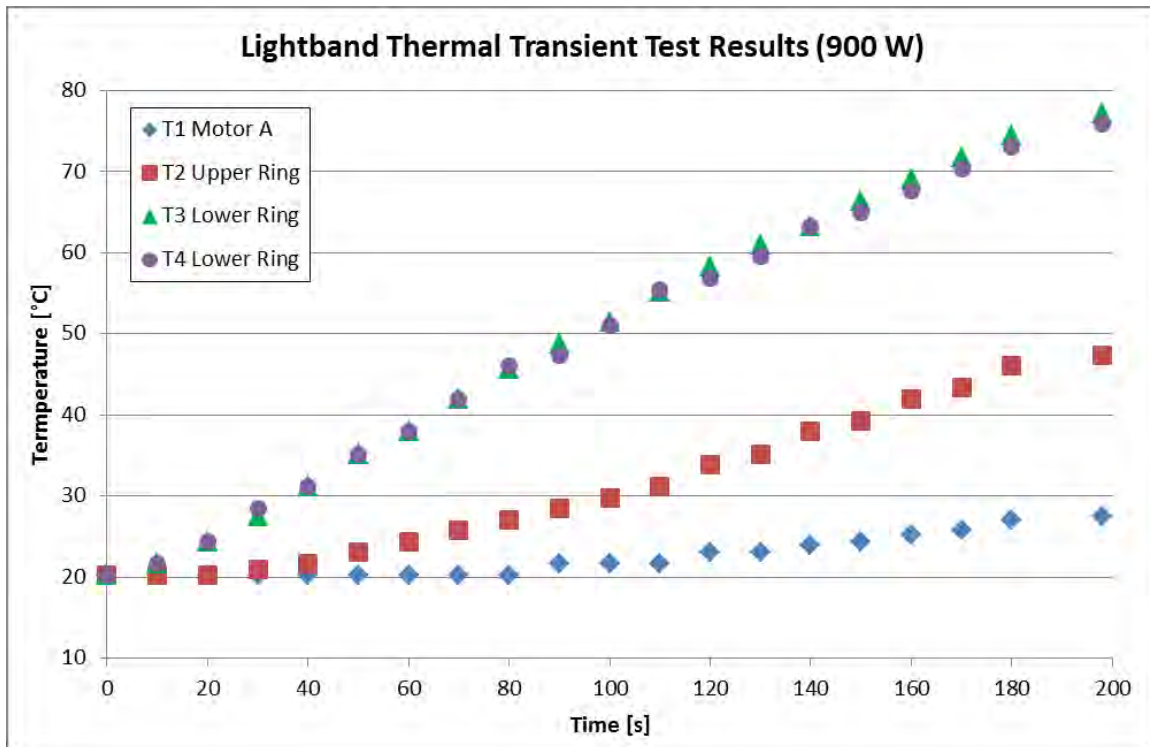

Figure 9-2: Thermal transient test results

10. Shock Properties

10.1 Maximum Shock Generated by MLB

The MLB generates shock during the separation event. To characterize this shock accelerometers were fastened to structures adjoining the Upper and Lower Rings. The accelerometers measured the expected shock at the simulated space and launch vehicle interfaces. Figure 10-2 displays the MaxiMax shock response spectrums (SRS) for three MLB sizes. The SRS's were calculated with 1/6 octave band frequencies and 5% damping. The test configuration and adjoining structures were different for each size. See Figure 10-3. Adjoining structures and MLB Retaining Ring preload affect the SRS values. Therefore, the values presented should be used only for preliminary analysis. Figure 10-4 shows the time history data.

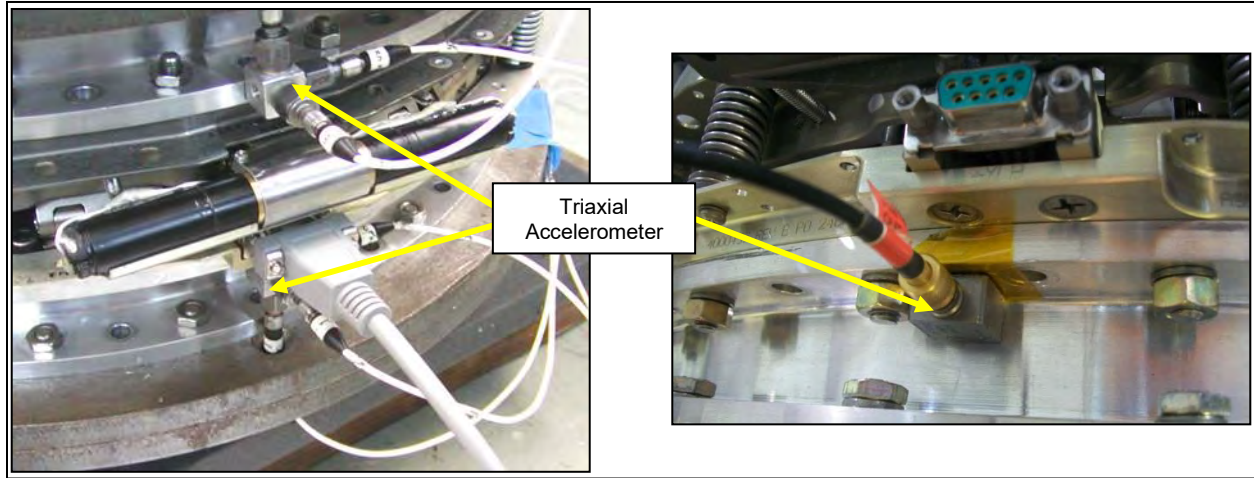

Figure 10-1: Examples of tri-axial accelerometers bonded to Transition Rings, fastened to the MLB.

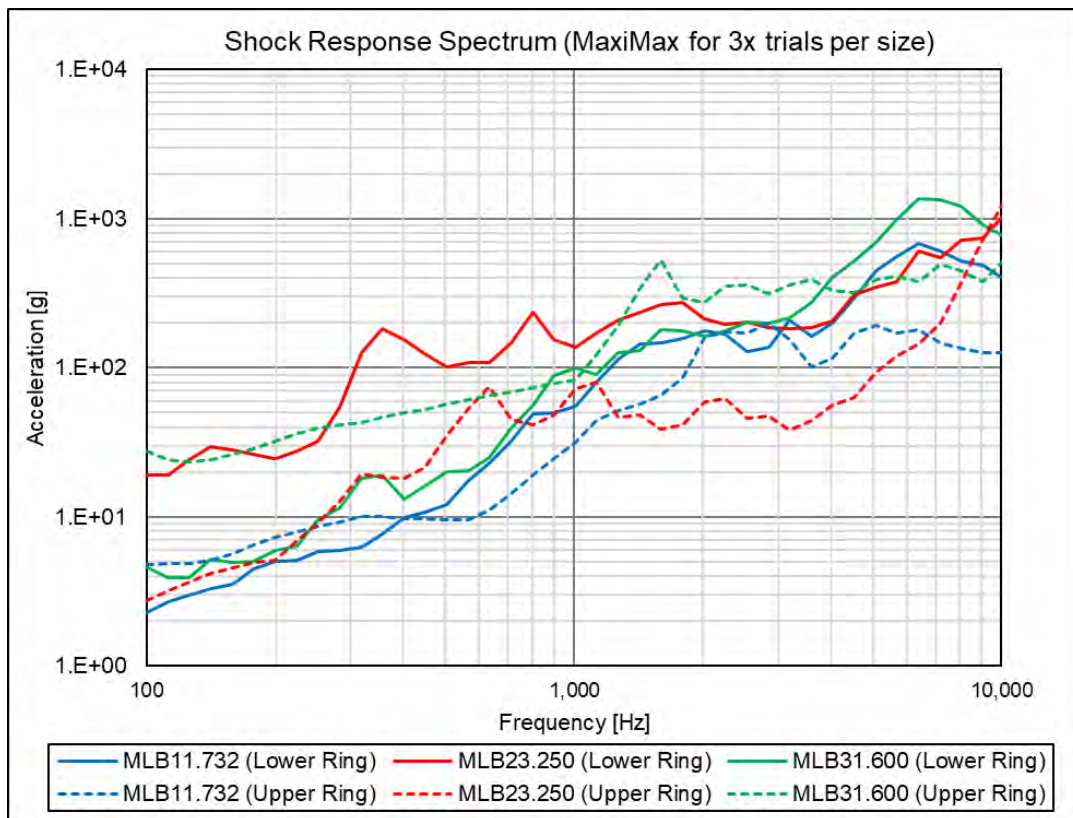

Figure 10-2: MLB generated shock response spectrum

The MLB31.600 Upper Ring spike around 1,600 Hz was due to a fixture resonance.

A unique test configuration was used for each MLB.

- MLB11.732: Lower Ring bolted directly to thick aluminum and steel plates. Upper Ring bolted to a Transition Ring supporting several aluminum plates. Upper Ring remained stationary (initiation not separation).
- MLB23.250-32: Lower Ring bolted directly to a thick aluminum plate. Upper Ring bolted directly to a heavy aluminum bell jar hanging from a crane. Lower Ring allowed to fall onto foam during separation.
- MLB31.600-48: Lower and Upper Rings attached to Transition Rings on PSC's separation reliability test fixture. Upper Ring translates on air bearings during separation.



Figure 10-3: Test configurations for MLB generated shock

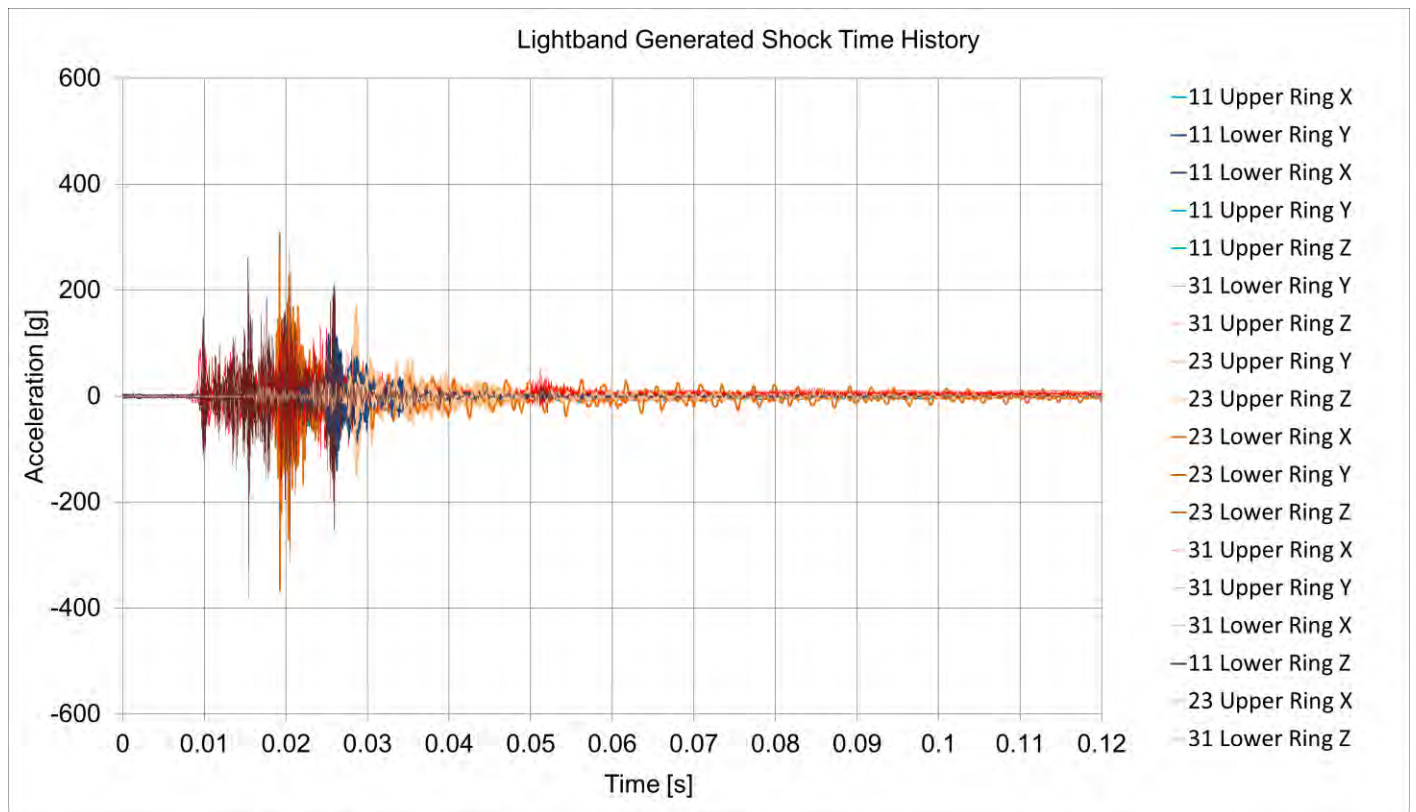

Figure 10-4: Nominal shock response time history from the MLB separation

11. Reliability

Probability of Success	Confidence Level [%]
>0.999	60
>0.998	85
>0.997	95
>0.996	97.5

Table 11-1: Minimum reliability and corresponding confidence level

Table 11-1 was calculated using Table 22.4 of *Space Vehicle Mechanisms* by Peter L. Conley given approximately 1,000 no failure tests. MLBs have cumulatively been operated more than 3,000 times during production, testing and flight operations. As of the revision date of this document, the MLB has operated successfully more than 200 times in spaceflight. There have been no failures to operate in spaceflight.

Prior to spaceflight, each MLB is separated numerous times to verify operability. These include operations conducted during acceptance testing by PSC and additional operations performed by the customer. As shown in Table 11-2, the MLB allows the user to verify operation multiple times before in-flight separation.

	Fairing Sep System	Pyrotechnic Sep System	MLB
Typical quantity of test separations on flight unit	0	0	≥11

Table 11-2: Comparison of separation system separations before launch

Alternatively, PSC tests development and qualification units to examine reliability limits and inform the allowable limits of MLBs in ground test and space flight. A typical qualification test will result in more than 100 separation tests on a single MLB. These separation tests are part of all environmental tests.

Because of the reusability of the MLB and the high production rate, it has been inexpensive to amass test data that is several orders of magnitude larger than competing pyrotechnic systems. The MLB was designed to be reusable with the intent of demonstrating reliability.

Stowing consumes about 10 times more energy than deploying. So, the act of stowing the MLB before flight accurately indicates the capacity of the MLB to deploy and separate on orbit. If the MLB cannot be stowed, it indicates one of the motors is inoperable. The setting-for-flight operation (completed after the MLB is stowed) is a low power operation completed by both motors. If the current into the motors is monitored during this operation as prescribed in the most recent version PSC Document *2000781 MkII MLB Operating Procedure*, it will provide data to clearly indicate the capacity of the MLB to operate properly on orbit.

Maximum reliability of the MLB can be attained by minimizing the power conducted into the MLB and the number of cycles. Specifically, avoid unnecessary stow/deploy operations and minimize applied voltage levels as higher voltages will put more power into the mechanism. More power increases stresses to the Motor Bracket Assembly.

PSC constantly advances the MLB technology to increase reliability during ground test and in flight. By building and testing hundreds of flight MLBs per year, PSC engineers are made aware of trends that may compromise reliability.

12. Failure Modes and Effects Analysis (FMEA)

FMEA has four major sections: Primary Load Path, Motor Bracket Assembly, Subsystems, and Human Error.

The most common source of MLB failure has been customer user error because they neglected to read the operating procedure and receive training. Here are a few examples:

- A customer disregarded the operating procedure, bypassed the Limit Switches, turned off the power supply's current limit, and then used a screw driver to help the MLB stow. It was already stowed, which led to irreparable damage.

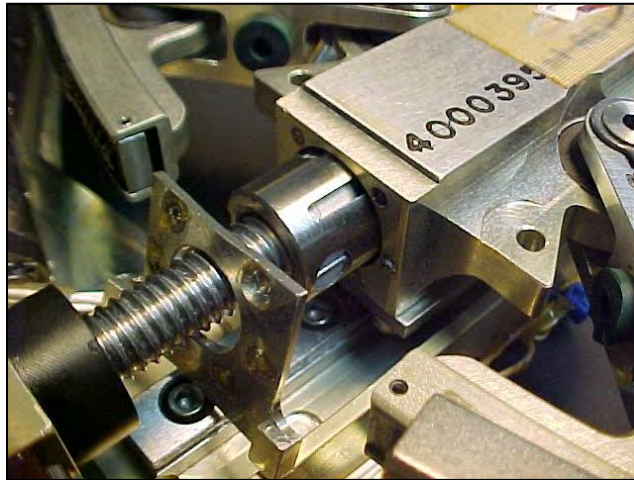

Figure 12-1: End plate ripped off Sliding Tube because the MLB was not properly operated

- A customer forgot to force limit vibration inputs while performing a random vibration test and cracked an MLB Leaf then continued the test without noticing the cracked Leaf.

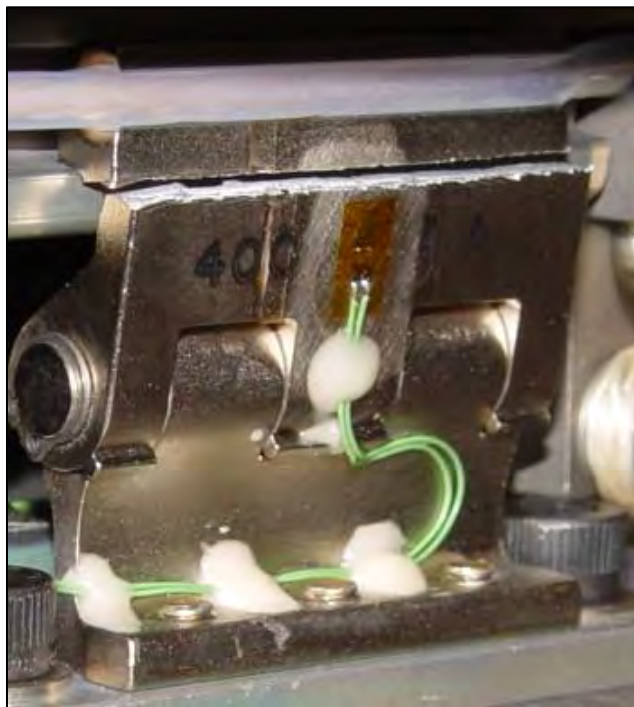

Figure 12-2: A Leaf from an MLB cracked in half during a flawed random vibration test

- A customer had PSC engineers fly to Kodiak, Alaska to fix what was thought to be a broken MLB only to discover the customer was improperly operating a multimeter used to verify MLB operation.
- A customer forgot the MLB was connected to the power supply during a ground test of the initiation electronics. The MLB deployed and the separated cantilevered structure damaged the MLB.
- A customer incorrectly wired the cable from the launch vehicle to the MLB resulting in stalled motors for approximately 60 seconds.

The most common errors arise when customers fail to follow procedures properly or fail to verify electrical connections. These failures typically occur soon after receipt by customer and at considerable cost. To prevent this failure mode, all MLB users are required to complete the MLB training course provided by PSC at no extra cost and urged to study this manual in detail. See Section 23.

13. Cleanliness & Handling

13.1 Customer Cleanliness and Handling Requirements

Users shall store and operate the MLB in a visibly clean environment. The MLB shall be covered when not in use. The MLB may be handled without gloves, as long as handling precautions outlined in *2000781 MkII MLB Operating Procedure* are followed.

13.2 Cleanliness and Handling at PSC

The MLB is assembled and tested in a visibly clean environment. The thermal vacuum acceptance test that every MLB undergoes tends to boil-off volatile contaminants. As such, the thermal-vacuum test tends to clean the MLB of volatile materials or expose the presence of unacceptable contamination. The MLBs are covered when not in use at PSC. Section 24 outlines the contamination control methods used in shipping.

13.3 Cleanliness Precautions

The Viton bumpers (Deploy Stops) can shed debris (<0.005 square inch) if the MLB is stowed and deployed beyond its useable life. See Figure 7-12 for an image of the Viton bumpers and Section 7.15 for discussion of MLB usable life.

When the MLB is separated and not attached to other structures, it is in its most flexible and fragile state. When the motors are exposed to accidental loading the mechanical junctions may loosen. In extreme cases this could lead to cracking of motor components or debris creation.

The Separation Connectors can collect debris when the MLB is in a deployed state. This can lead to inadvertent intermittencies. PSC recommends that the exposed Separation Connector pins be covered when in the deployed state for extended durations.

Lubricant (Braycote 601 and molybdenum disulfide mixture) is applied in several locations and should not be removed by cleaning processes. Lubricant is located in the Motor Bracket Assembly, the Retaining Ring Assembly, the Leaf Assemblies, and in the accepting groove of the Upper Ring. See *2000781 MkII MLB Operating Procedure* for additional details.

13.4 Part Markings

Users shall store and operate the MLB such that no damage occurs to part markings (engravings, stickers, ink, etc.). PSC shall be contacted if there is any visible damage to the part marking upon receipt of the unit.

14. Storage Requirements

Store the MLB in a sealed enclosure in relative humidity of less than 95% at temperatures between 0 and 50°C. If possible, store the MLB in the deployed state to minimize strain on components. The maximum allowable storage durations are shown in Table 5-1.

The Separation Springs do not appreciably creep due to long term storage and the MLB can remain stowed and ready for separation. Separation Springs are tested for creep before installation on an MLB. The shelf life of an MLB is estimated to be 20 years, but PSC shall be contacted for approval before operation if any of the allowable storage durations are exceeded.

An MLB was stowed outside the International Space Station for 8.5 months. It then successfully deployed the ROSA solar array.



Figure 14-1: 23 inch MLB deploying ROSA from ISS

Two other extreme storage environments were the STS-116 and STS-127 missions. In those cases, six MLBs (3x per mission) were on-orbit in shuttle's cargo bay for more than two weeks after sitting on the launch pad for several months. The uncontrolled thermal cycling, about 250 cycles from -25 to +70°C at 10^{-9} Torr, is an extremely rigorous verification of the MLB's capacity to operate after long-term storage. In total, these MLBs were stowed for about 5 months before deployment.

In another example, an MLB on the STP-S26 mission remained stowed on-orbit for more than 90 days because of a satellite communication issue. Upon receiving the separation signal from the final stage 3 months later than planned, the MLB separated nominally.

15. MLB Operation & Integration

CAUTION: Operating the MLB before receiving training from PSC will void the MLB's warranty. See Section 23.

All MLB users are required to complete a training course conducted by PSC engineers. It is the customer's responsibility to ensure that they have been trained before operating the Lightband. This training is included in the cost of the Lightband and generally performed at PSC's facility in Silver Spring, Maryland. Remote training is available at additional cost. Without this training the probability of user-induced failure will be high. See Section 23.

The latest revision of PSC Document *2000781 MkII MLB Operating Procedure* details the steps to integrate and operate the MLB.

15.1 Access to Fasteners

When the MLB is separated, the fasteners to the adjoining structures are readily accessible. When the MLB is stowed, access to fasteners is limited but possible if there is access from the inside (such as in ESPA). Hex drivers (Allen keys) must be shortened.

15.2 Vertical and Horizontal Integration to Adjoining Vehicles

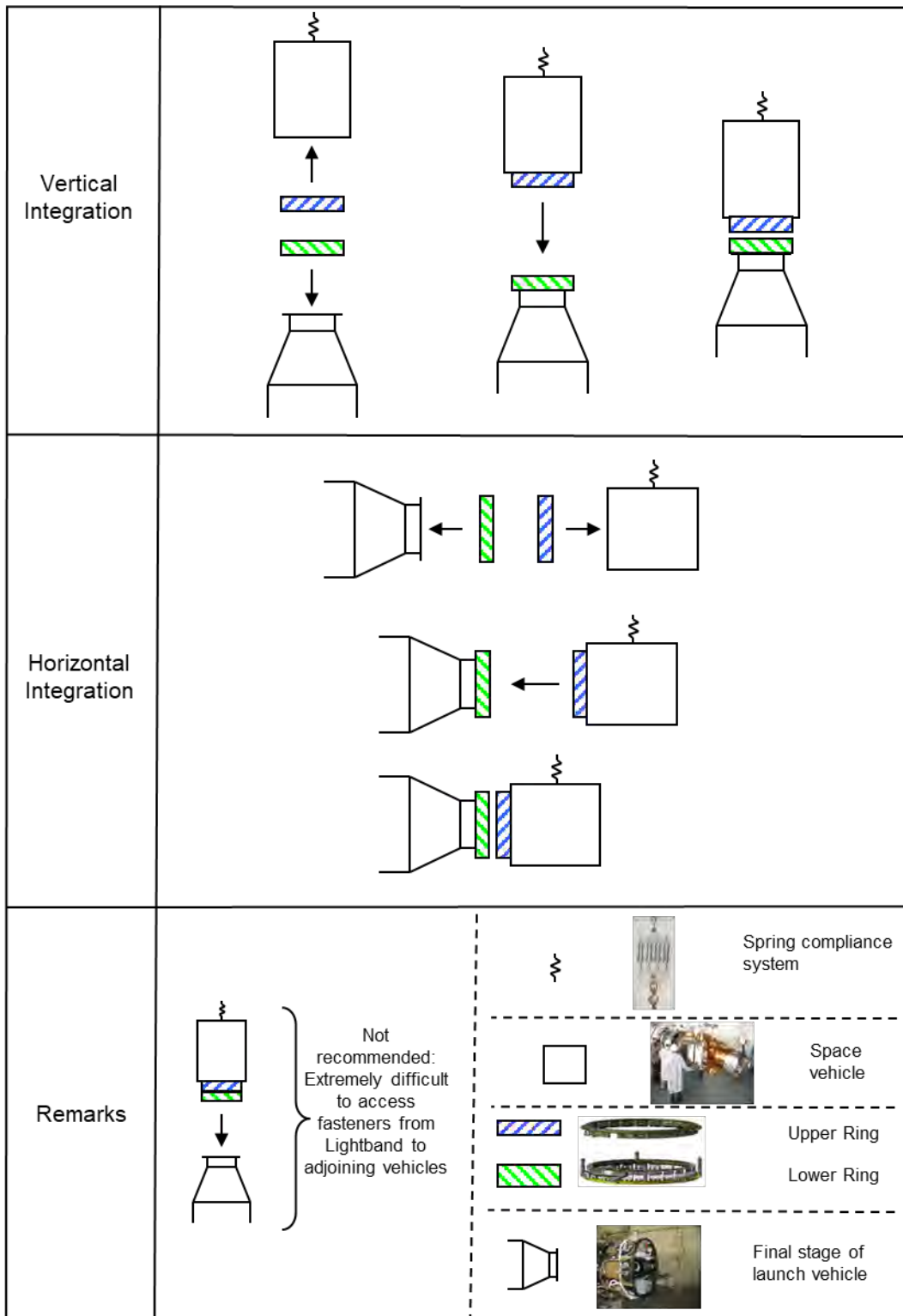

Figure 15-1: Typical vertical and horizontal integration methods

Vertical integration allows the weight of the space vehicle to compress the Separation Springs. Horizontal integration requires the capacity to compress the Separation Springs (such as a clamp that straddled the space vehicle). PSC manufactures proprietary Lightband Compression Tools that can be used for this purpose as well. See Section 15.3.

The compliance of the entire stack needs to be assessed to properly integrate the MLB. When the MLB is stowed as part of the integration process, the entire system will be structurally indeterminate. If the space vehicle and Upper Ring are too far from the Lower Ring or improperly aligned, the MLB will have to pull the space vehicle down and vice versa. To minimize this effect, a compliance spring and/or a more precise control of space vehicle position in all six degrees of freedom is necessary.

Flatness of the adjoining surfaces should be within the flatness requirement defined in Table 5-1. If flatness requirements are not met by the structure, shims (epoxy or metal) can be used to attain the required flatness.

For detailed integration instructions, see the most recent revision of 2000781 MkII MLB Operating Procedure.

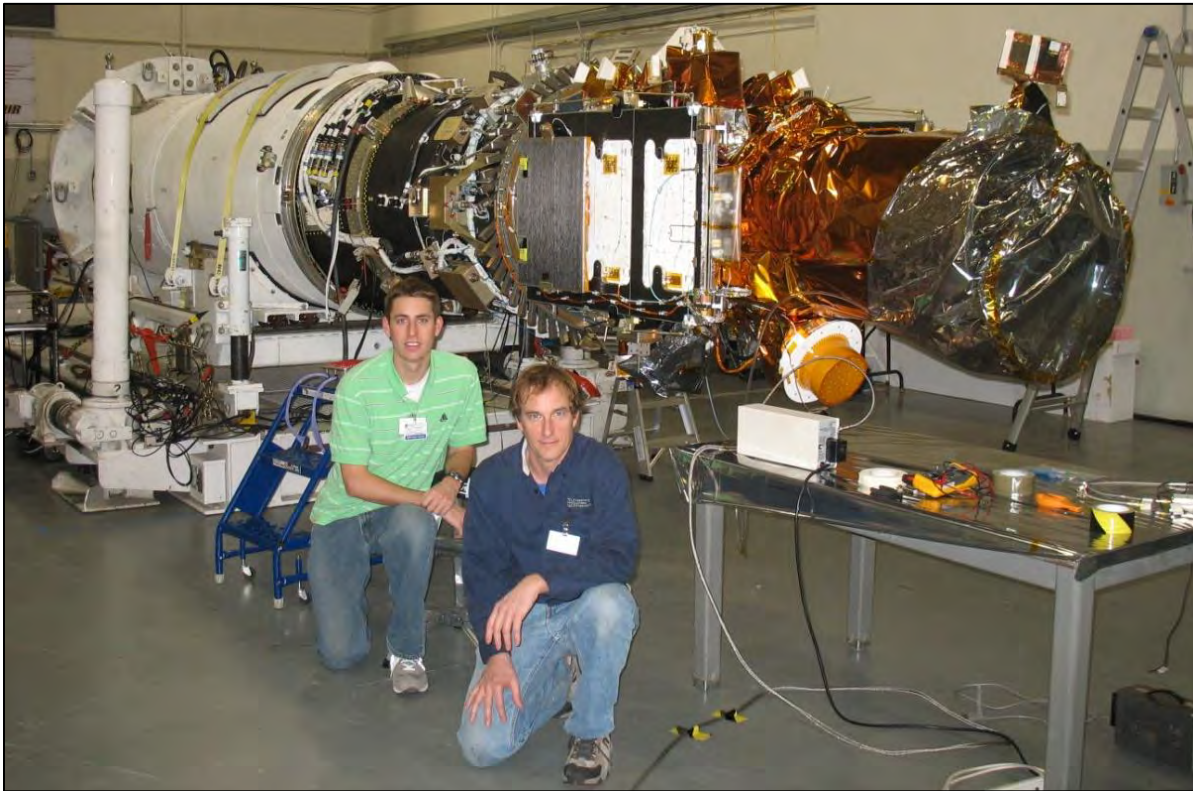

Figure 15-2: PSC engineers perform a horizontal integration (with an isolation system) of a space vehicle onto a launch vehicle

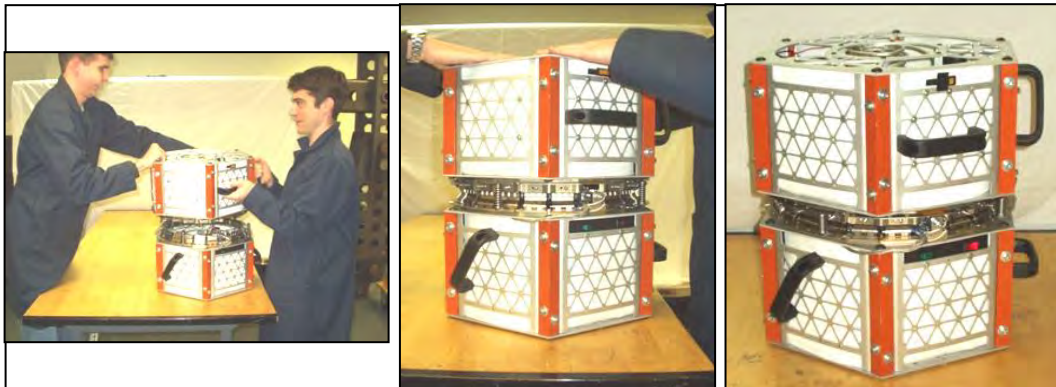

Figure 15-3: PSC customers perform a vertical integration (NanoSat)



Figure 15-4: PSC engineers perform a vertical integration (CAPE-ICU-I)

15.3 Lightband Compression Tools

A force must be generated to compress the Separation Springs and mate the MLB halves prior to stowing. Lightband Compression Tools (LCTs) are instruments used to properly compress the MLB. LCTs are ideal for situations in which the MLB must be stowed horizontally or when the required compressive weight cannot be applied to the Upper Ring payload in a vertical configuration. Consider the entire program use of the MLB, including testing, as the space vehicle mass may be lighter at certain stages of the program. LCTs are flight qualified and designed to be flown. However, the customer may remove them after integration if desired. See the most recent revision of 2000781 MkII MLB Operating Procedure. Equations below estimate the required qty. of LCTs.

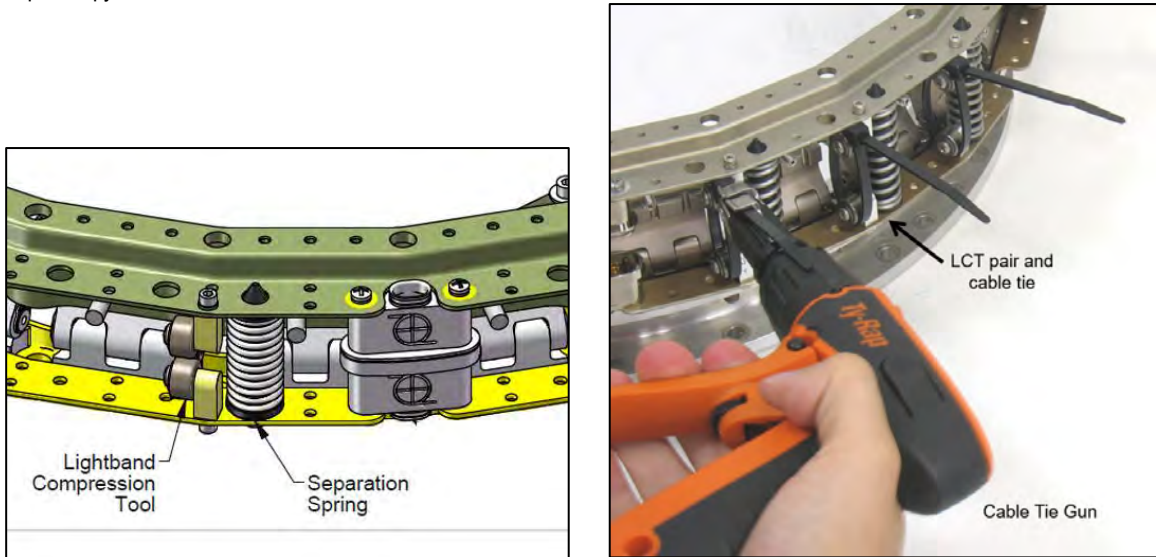

Figure 15-5: Use of LCTs to compress MLB

15.3.1 Vertical Integration

In vertical integration the weight of the space vehicle assists in compression of the MLB's Separation Springs. Equation (10) will estimate the required number of LCT pairs. If negative, no LCTs are required.

$$LCT = S - \frac{SV}{111} \tag{10}$$

Where:

SV is the space vehicle weight in Newtons [N].

S is the Separation Spring qty. [-] (see Section 7.22 to estimate).

LCT is the minimum number of Lightband Compression Tools required [pairs].

15.3.2 Horizontal Integration

In horizontal integration the entire force necessary to compress all Separation Springs must be generated from LCTs. Therefore, the required number of LCT pairs is equivalent to the number of Springs.

$$LCT = S \tag{11}$$

Where:

S is the Separation Spring qty. [-] (see Section 7.22 to estimate).

LCT is the minimum number of Lightband Compression Tools required [pairs].

16. Acceptance Testing

PSC completes two standard acceptance tests (Vibration and Thermal Vacuum) on standard flight MLBs prior to delivery. FLT MLBs undergo bench-top separations with varying voltage levels and number of motors to verify reliability. This is part of PSC's quality assurance plan. EDU MLBs do not go through standard acceptance tests. Just like during assembly, all testing is performed by a team of PSC engineers. Two trained PSC staff sign-off on individual steps in testing procedures (one acts as the test director, the other as quality assurance) and a Test Complete Review (TCR) is completed as-required.

The MLB is tested as "a unit" with respect to the definition in MIL-STD-1540. However, PSC's testing of the MLB does not include the customer's wiring harness, which as noted earlier can weigh as much as or more than the MLB. GSE Transition Rings are fastened to the MLB during testing to mimic flight-like structural, thermal, and dynamic boundary conditions. There is no fixed sequence for these acceptance tests.

PSC writes, executes, and approves all test plans. PSC also takes any corrective action if anomalies arise after required customer notification. If requested, customers are supplied the test plans prior to test start. Prior to these tests, PSC completes several bench-top separation operations to tune-in the preload force of the Retaining Ring and then verify proper operation.

Event	Standard or Custom?	Typical Number of Separations Performed
Bench-top separation	Standard	9
Vibration Test	Standard	1
Thermal Vacuum Test	Standard	1
Separation Reliability Test	Custom	6 to 11
Strength Test	Custom	1
Shock Test	Custom	1
Total (excluding custom tests)		11 to 16

Table 16-1: FLT MLB operations summary

16.1 Standard Acceptance Tests

Each test in this section is performed on every flight MLB built by PSC. The test parameters default to those shown herein. Any adjustment to these parameters is considered custom work.

16.1.1 Random Vibration Test

Location: Qualified Vibration Test Facility

Objective: Verify workmanship

Test Description: During this test, the test item will be exposed to a controlled random vibration profile in three orthogonal axes. Upon completion of vibration, the test item will be separated and then formally inspected.

Standard Levels: Figure 16-2 defines the nominal acceptance test random vibration profile. These values are derived from *MIL-STD-1540-E Test Requirements for Launch, Upper-Stage, and Space Vehicles (SMC-TR-06-11)*.

Number of separations: One (1) following the last of three axes of vibration

WARNING: These vibration levels shall not be applied to the MLB when the MLB is supporting a substantial mass. The prescribed environment below is component level and for the MLB alone. When the MLB is supporting a structure, engineers must determine how the vibration environment will generate line loading and how much of the MLB's fatigue life will be consumed.

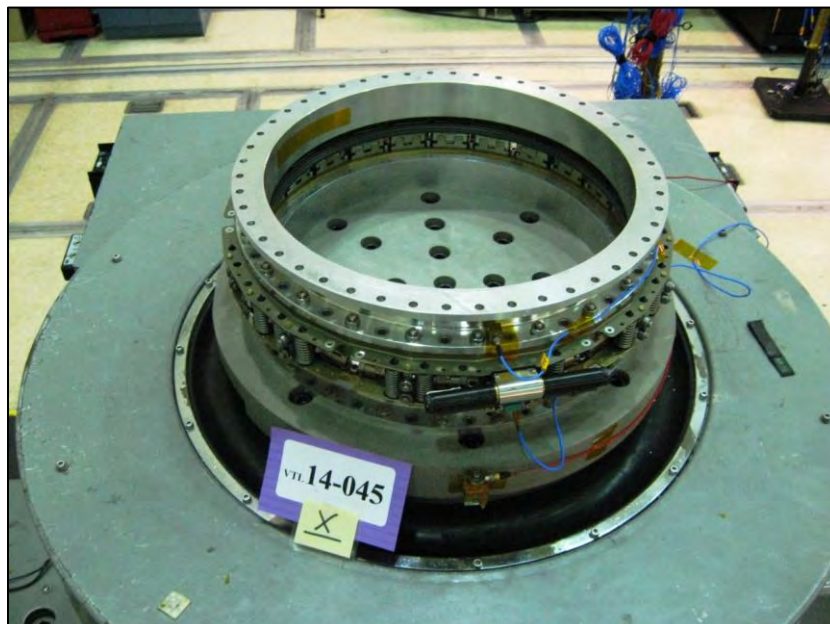

Figure 16-1: Nominal vibration test configuration, MLB15.000 shown

- Notes: (1) In a separation, springs elongate at least 0.7 inches. In an initiation, springs elongate 0.0 inches.
 (2) Control bandwidths may be combined for tolerance evaluation purposes.
 (3) Additional accelerometers shall follow the same naming convention wherein C# signifies control and R# signifies response.
 (4) Narrow Bandwidth Exceedance tolerance is the maximum width that a control signal may exceed the control tolerance.

Test Facility Data Transfer Requirements

Provide tabulated data and plots of the ASD profiles.

Random Vibration Tolerances

Freq. [Hz]	Random Vibration Profile ASD [g^2/Hz]	Upper Ctrl Limit ASD [g^2/Hz]	Lower Ctrl Limit ASD [g^2/Hz]
20	0.013	0.018	0.009
50	0.080	0.113	0.057
800	0.080	0.113	0.057
1,000	0.051	0.073	0.036
1,000	0.051	0.103	0.026
2,000	0.013	0.026	0.007

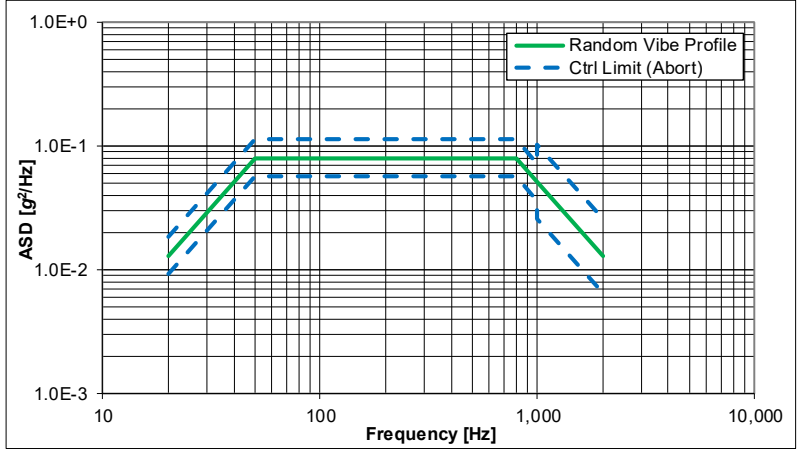

EDE Parameters

Parameter	Value	Tolerance
Overall Level [g_{rms}]	10.0	± 1.0 dB
Duration per axis [s]	61	+5/-1
Axes tested [-]	X, Y, Z	-
Control Strategy [-]	Max	-
Ctrl tolerance, 20-1,000 Hz [\pm dB]	1.5	-
Ctrl tolerance, >1,000 Hz [\pm dB]	3.0	-
Ctrl. Bandwidth Resolution [Hz]	5	Max
NBE, 20-100 [Hz] (4)	10	Max
NBE, 100-1,000 [Hz] (4)	10% of midband freq.	Max
NBE, 1,000-2,000 [Hz] (4)	100	Max
Off-Axis Ctrl. Accel Overall Level [g_{rms}]	In-axis input level	Max
Random vbe DOF per channel [-]	120	± 20
Data Sampling Rate [Hz]	5,000	minimum

Accelerometer Parameters

Name (3)	Designation	Type	Mtg. Location, X-axis	Mtg. Location, Y/Z axes
C1	Control	Triaxial	Lower Ring's adjoining structure	Along +Y _{LB}
C2	Control	Triaxial	Lower Ring's adjoining structure	At test director's discretion. Default to along +Z _{LB} .
R1	Response	Triaxial	Upper Ring's adjoining structure	Along +Y _{LB}

Functional Test Following Vibration

Operation (1)	Cmd. Voltage [V]	Motor(s) Powered
Separation	28.0	Both

Figure 16-2: Standard random vibration test requirements

16.1.2 Thermal-Vacuum Test

Location: PSC

Objective: Verify separation at temperature and pressure extremes

Test Description: During this test, the MLB will be thermally cycled in a chamber that maintains vacuum. The MLB will be separated while still under vacuum at the conclusion of thermal cycling. Upon test completion, the MLB is removed from the chamber and formally inspected.

Test Parameters:

Temperature Range [°C]: -24 to +61 (Values may be exceeded at PSC's discretion).

Thermal Cycles [-]: ≥4

Separation Temperature [-]: hot or cold extreme at PSC's discretion

Pressure at Separation [Torr]: <1E-4

Powered Motor for separation [-]: Single motor (either motor A or motor B at PSC's discretion).

PSC often tests numerous MLBs and/or ALBs simultaneously. In that case, the control temperature sensor will typically be placed on the item with the highest thermal resistance (mass).

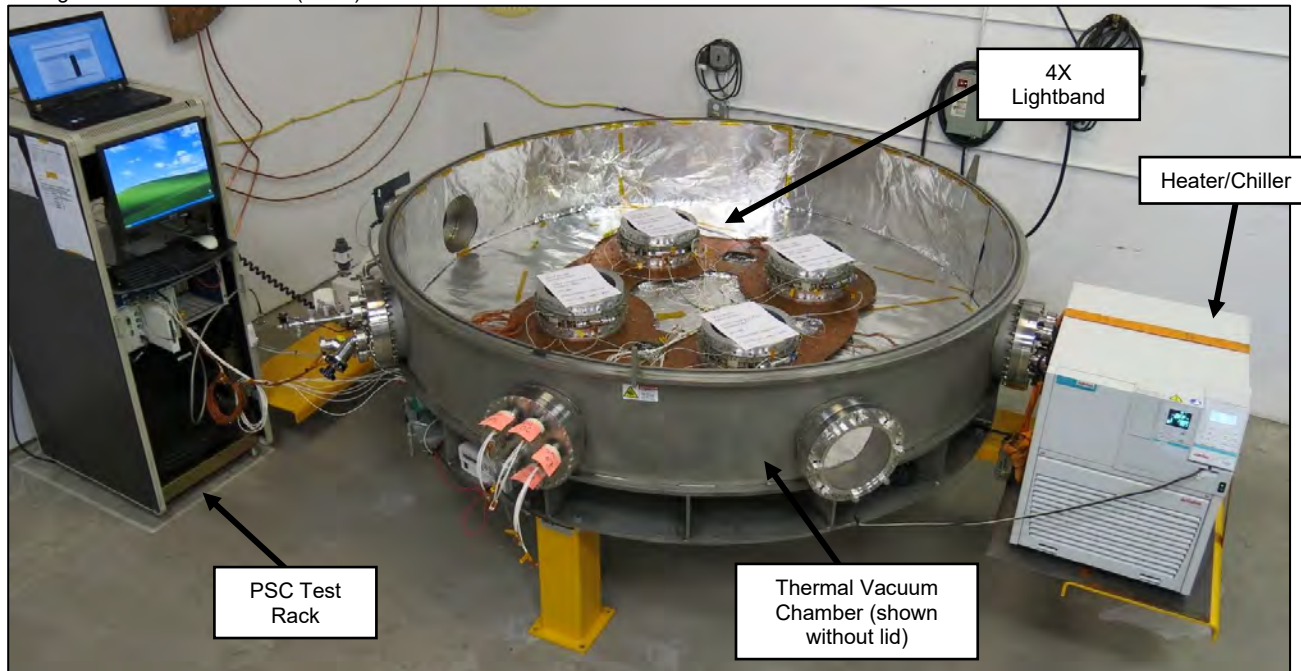

Figure 16-3: 4X MLB11.732 inside the PSC thermal vacuum chamber

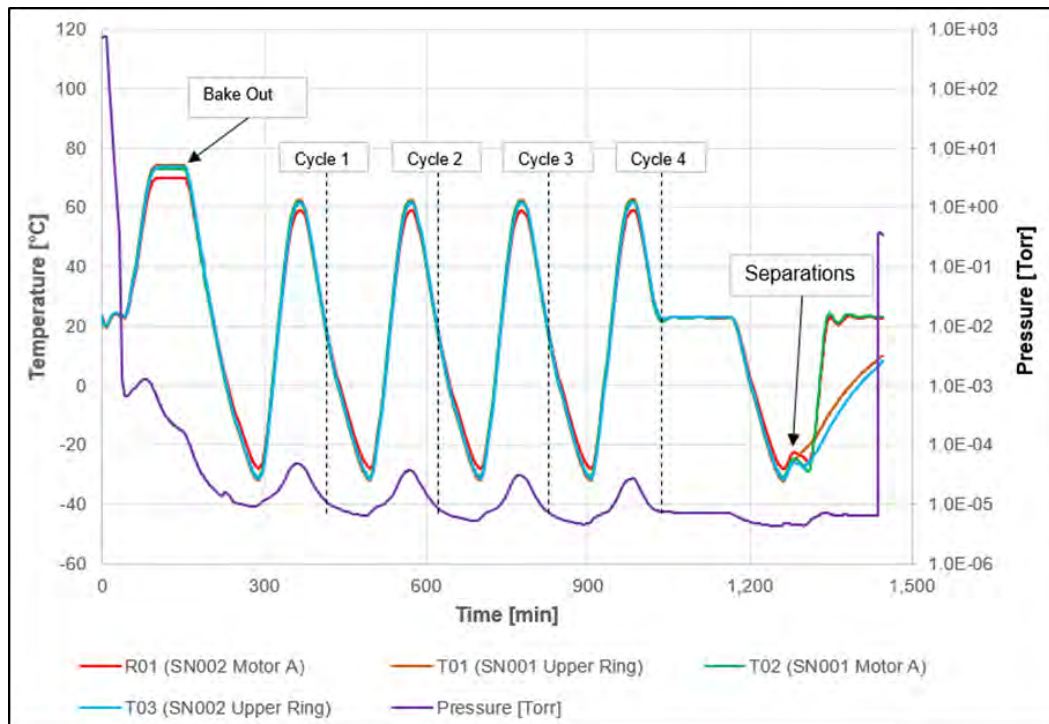

Figure 16-4: Sample data from a thermal vacuum test of two MLBs

16.2 Custom Acceptance Tests

The following acceptance tests are not performed for standard MLBs. Criteria that determine the need for these tests are stated herein. PSC reserves the right to perform these tests on any flight MLB if desired.

An MLB that requires any of these tests shall be considered custom. Custom MLBs incur additional cost and schedule duration over Standard MLBs.

16.2.1 Separation Reliability Test

Location: PSC

Objective: Verify time to initiate, translational separating energy, rotation rates and repeatability

Test Description: During this test, the test item is repeatedly separated on a 5 degree-of-freedom test fixture. For each separation, the separation velocity and rotation rates of the separating half of the fixture are measured along with the standard operation data such as motor current draw and time to initiate. If necessary, the configuration and quantity of Separation Springs may be modified to meet separation energy and rotation rate requirements. Upon completion of 5 consecutive separations where all requirements are met, the test item is formally inspected.

Typical Levels: See Table 16-2. Typical Separation Reliability tests do not account for any center of mass offsets in the Y_{LB} or Z_{LB} axes. Performing a Separation Reliability test with anything other than the levels in Table 16-2 will warrant additional cost and schedule duration.

Axes: All axes presented in the test data correspond to the MLB coordinate system. PSC does not convert to the customer's coordinate system.

Test Correlated Flight Predictions: Separation Reliability tests do not identically match flight mass properties. However, the customer can predict flight separation velocity and rotation rates using the test results in the delivered test report.

Parameter	Test Value	Tolerance	Units
Separating Mass (simulates payload)	See Table 16-3	See Table 16-3	See Table 16-3
Rotation rates for 8.000, 11.732 and 13.000 MLBs	0.0	$\pm 5.0^{(1)}$	deg/s
Rotation rates for 15.000 and larger MLBs	0.0	$\pm 1.0^{(1)}$	deg/s
Separating Energy (x-axis translation)	Customer requirement	± 2.0	J
CM_x :	See Table 16-3	See Table 16-3	See Table 16-3
CM_y :	0.0	± 0.05	in
CM_z :	0.0	± 0.05	in
MOI	See Table 16-3	See Table 16-3	See Table 16-3
Number of separations in final configuration	5	+5/-0	-
Commanded voltage and motor(s) powered	1) 28 V, both motors 2) 28 V, motor A 3) 28 V, motor B 4) 32 V, motor A 5) 24 V, motor B	-	-

Table 16-2: Typical Separation Reliability test parameters

MLB Diameter [in]	Separating Mass [lb _m]	Separating Mass Tol. [-]	CM_x [in]	CM_x Tol. [in]	MOI_x [lb _m ·in ²] ⁽²⁾	MOI_y [lb _m ·in ²] ⁽²⁾	MOI_z [lb _m ·in ²] ⁽²⁾	MOI Tol. [-]
8.000	107	$\pm 25\%$	14.8	± 0.5	5,161	27,616	29,839	$\pm 10\%$
11.732	114	$\pm 25\%$	14.8	± 0.5	6,777	32,013	33,978	$\pm 10\%$
13.000	166	$\pm 25\%$	13.3	± 0.5	8,763	28,931	26,169	$\pm 10\%$
15.000	228	$\pm 25\%$	14.8	± 1.0	16,503	38,758	30,392	$\pm 10\%$
18.250	469	$\pm 25\%$	17.8	± 1.0	38,824	104,384	105,265	$\pm 10\%$
19.848	470	$\pm 25\%$	17.8	± 1.0	39,025	104,912	105,787	$\pm 10\%$
$\geq 23.250^6$	548	$\pm 25\%$	23.0	± 1.0	143,166	292,176	225,030	$\pm 10\%$

Table 16-3: Typical Separation Reliability inertial properties (values subject to change at PSC's discretion)

- (1) PSC does not scale rotation rates based on customer's payload inertia. For instance, if customer's payload inertia is less than test inertia, rotation rate tolerance will not be reduced. Scaling rotation rates classifies as a custom test and will warrant additional cost and schedule duration.
- (2) Only the portion of the separating mass above the spherical air bearing. Taken at the rotating arm's center of mass (center of spherical air bearing). Values subject to change.

⁶ The same inertial properties are used for MLB sizes greater than 23.250in.

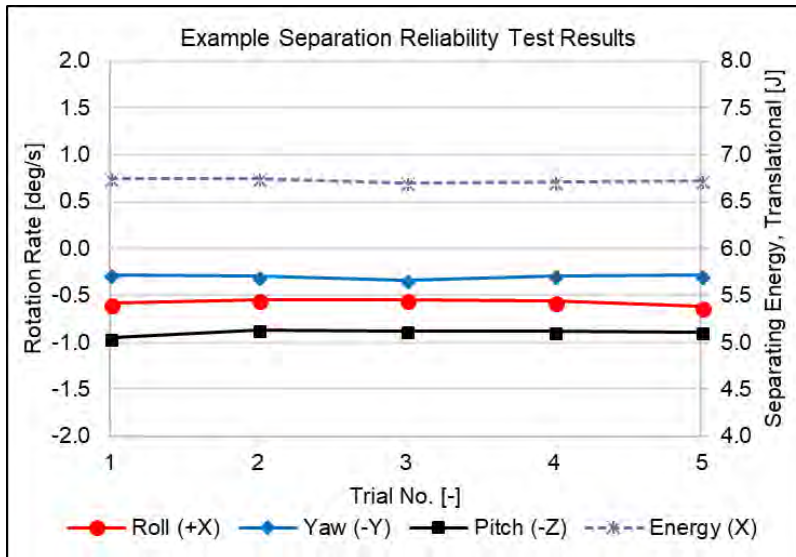

Figure 16-5: Example separation reliability test results summary

Reference Data					Motor Electrical Parameters								Measured Results				Analysis				
Trial No.	Sep. Qty.	Cfg. No.	.jvm File Name	Pre-Stow Weight [lb]	Post-SFF Weight [lb]	Motors Powered [-]	Cmd. Voltage [V]	Ch. A Peak Voltage [V]	Ch. B Peak Voltage [V]	Ch. A Energy [J]	Ch. B Energy [J]	Motors Powered ¹ Duration [s]	Roll (About +X) [deg/s]	Yaw (About -Y) [deg/s]	Pitch (About -Z) [deg/s]	Velocity [ft/s]	Roll Energy [J]	Yaw Energy [J]	Pitch Energy [J]	Separating Energy ⁴ [J]	
Tuning Trials																					
1	8	1	deploy_001	253.4	253.4	A&B	28.0	27.40	27.57	0.92	0.87	0.071	-0.68	-1.45	-0.57	1.12	2.1E-04	2.4E-03	3.2E-04	6.72	
2	8	2	deploy_002	252.7	252.9	A&B	28.0	27.46	27.43	0.90	0.89	0.069	-0.47	-0.33	-0.88	1.12	1.0E-04	1.2E-04	7.6E-04	6.71	
3	8	2	deploy_003	252.6	253.0	A&B	28.0	27.42	27.56	0.87	0.83	0.067	-0.54	-0.30	-0.84	1.13	1.3E-04	1.0E-04	7.0E-04	6.74	
Acceptance Trials																					
1	8	2	deploy_001	252.6	252.7	A&B	28.0	27.39	27.42	0.84	0.82	0.066	-0.58	-0.28	-0.95	1.13	1.6E-04	8.9E-05	9.0E-04	6.75	
2	8	2	deploy_002	252.6	252.8	A	28.0	27.23	24.34	1.82	0.00	0.079	-0.54	-0.30	-0.86	1.13	1.4E-04	9.8E-05	7.4E-04	6.75	
3	8	2	deploy_003	252.7	253.1	B	28.0	23.86	27.31	0.00	1.86	0.079	-0.55	-0.34	-0.88	1.12	1.4E-04	1.3E-04	7.6E-04	6.70	
4	8	2	deploy_004	252.7	252.9	A	32.0	31.12	27.58	2.04	0.00	0.070	-0.56	-0.29	-0.88	1.12	1.5E-04	9.4E-05	7.7E-04	6.71	
5	8	2	deploy_005	252.7	252.7	B	24.0	20.77	23.39	0.00	1.58	0.092	-0.62	-0.28	-0.89	1.12	1.8E-04	9.0E-05	7.8E-04	6.73	
Comments												Mean ²	0.077	-0.57	-0.30	-0.89	1.12	1.5E-04	1.0E-04	7.9E-04	6.73
1) Time from power on until either deploy limit switch initially opens.												Minimum ²	0.066	-0.62	-0.34	-0.95	1.12	1.4E-04	8.9E-05	7.4E-04	6.70
2) For acceptance trials only.												Maximum ²	0.092	-0.54	-0.28	-0.86	1.13	1.8E-04	1.3E-04	9.0E-04	6.75
3) Sep. Arm inertia about CM aligned with MLB coords:												Standard Deviation ²	0.010	0.031	0.022	0.035	0.002	1.7E-05	1.6E-05	6.4E-05	0.02
X (Roll)												Allowable Maximum	0.135	1.0	1.0	1.0	N/A	N/A	N/A	N/A	8.0
Y (Yaw)												Allowable Minimum	0.035	-1.0	-1.0	-1.0	N/A	N/A	N/A	N/A	4.0
Z (Pitch)																					

4) X-axis translational component. Use to predict flight separating velocity.

Figure 16-6: Example test results from separation reliability test

Figure 16-7 shows the filtered rate sensor data from acceptance trial 2 from Figure 16-6. The 'measured' rates are taken from an average of a short time period during the 'post-separation' event when the arm is free floating. For reference the measured rates reported in the test plan for this example were, Pitch = -0.86 deg/s, Roll = -0.54 deg/s and Yaw = -0.30 deg/s.

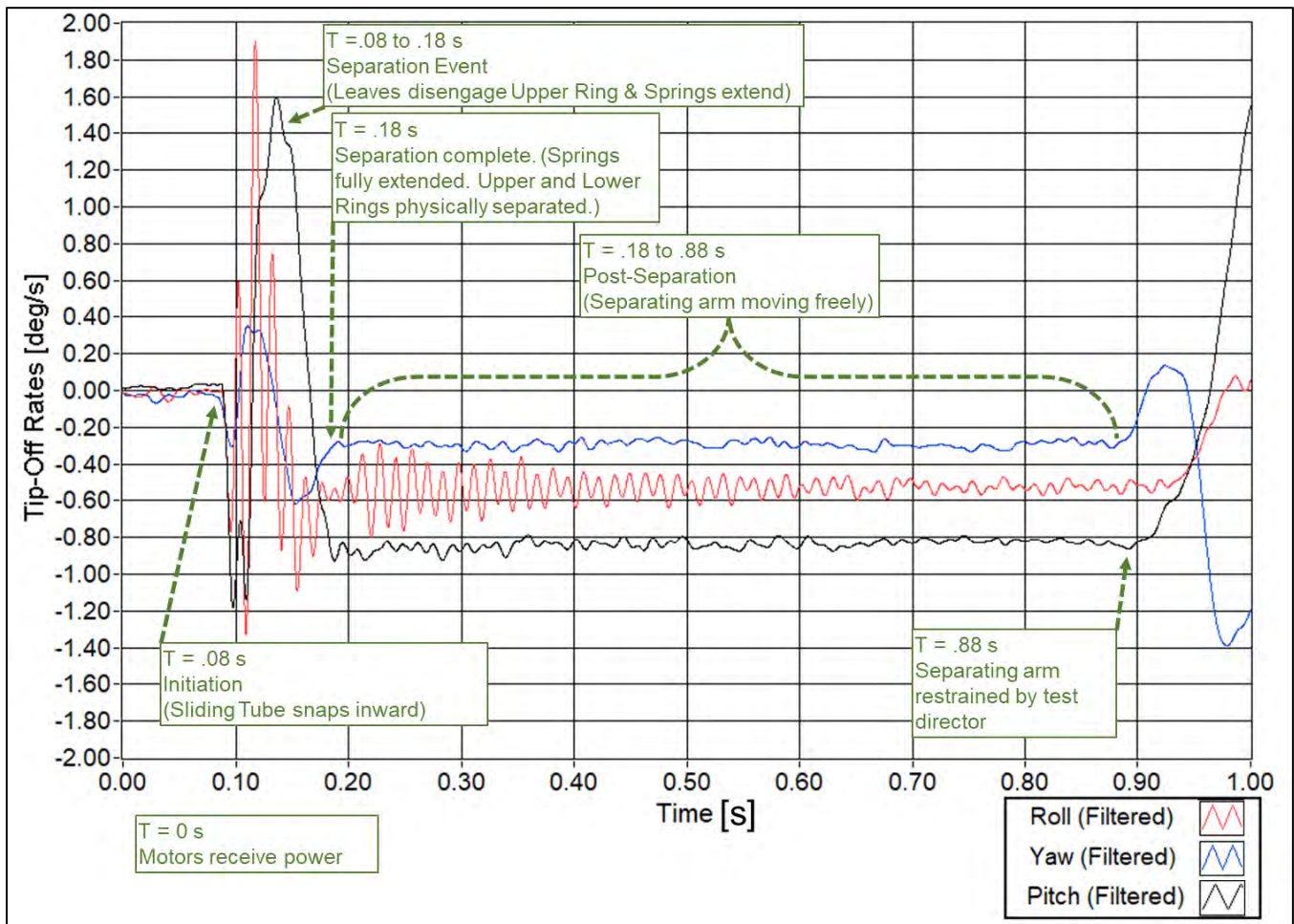

Figure 16-7: Rotation rates during separation event

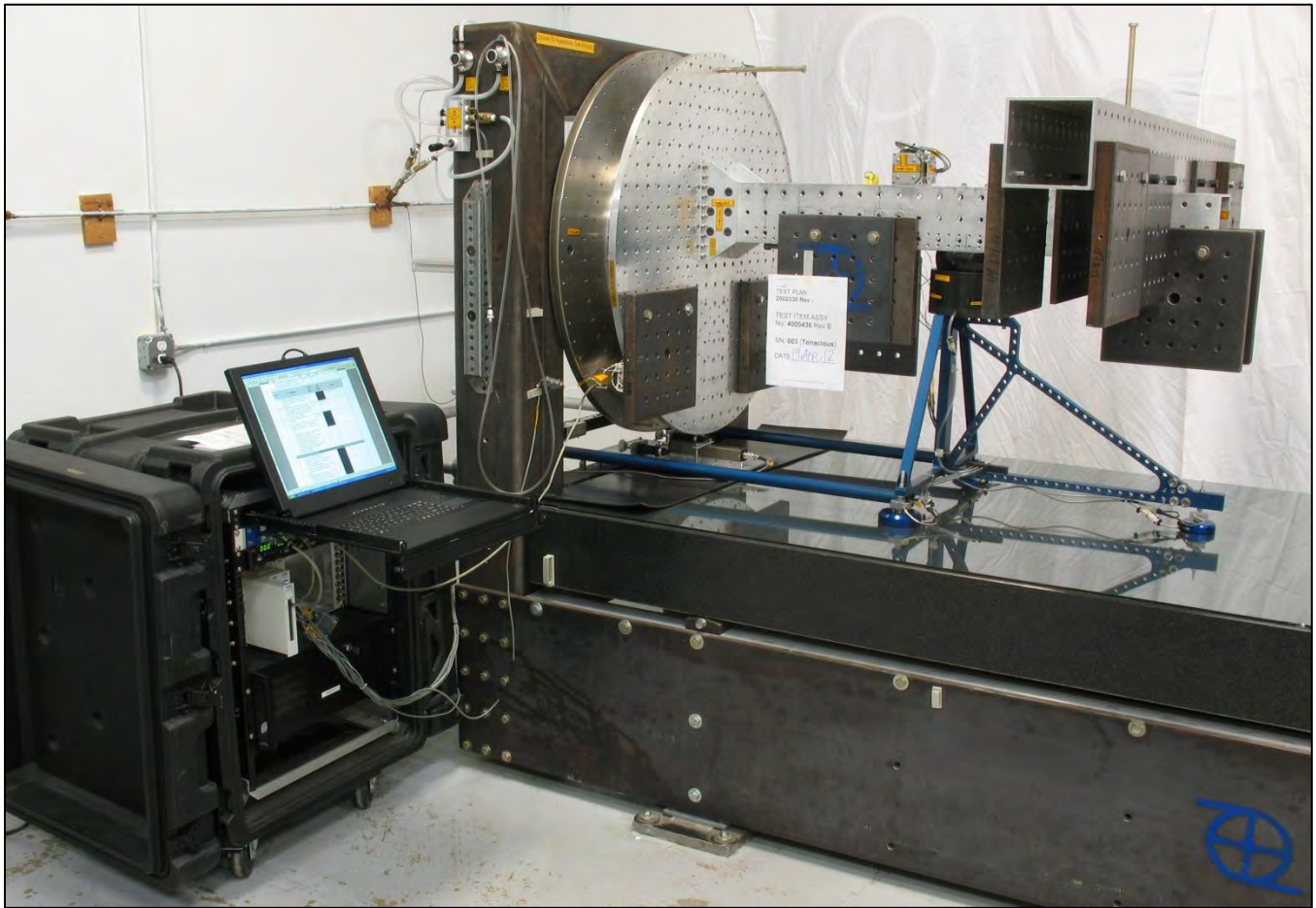

Figure 16-8: PSC's separation reliability fixture

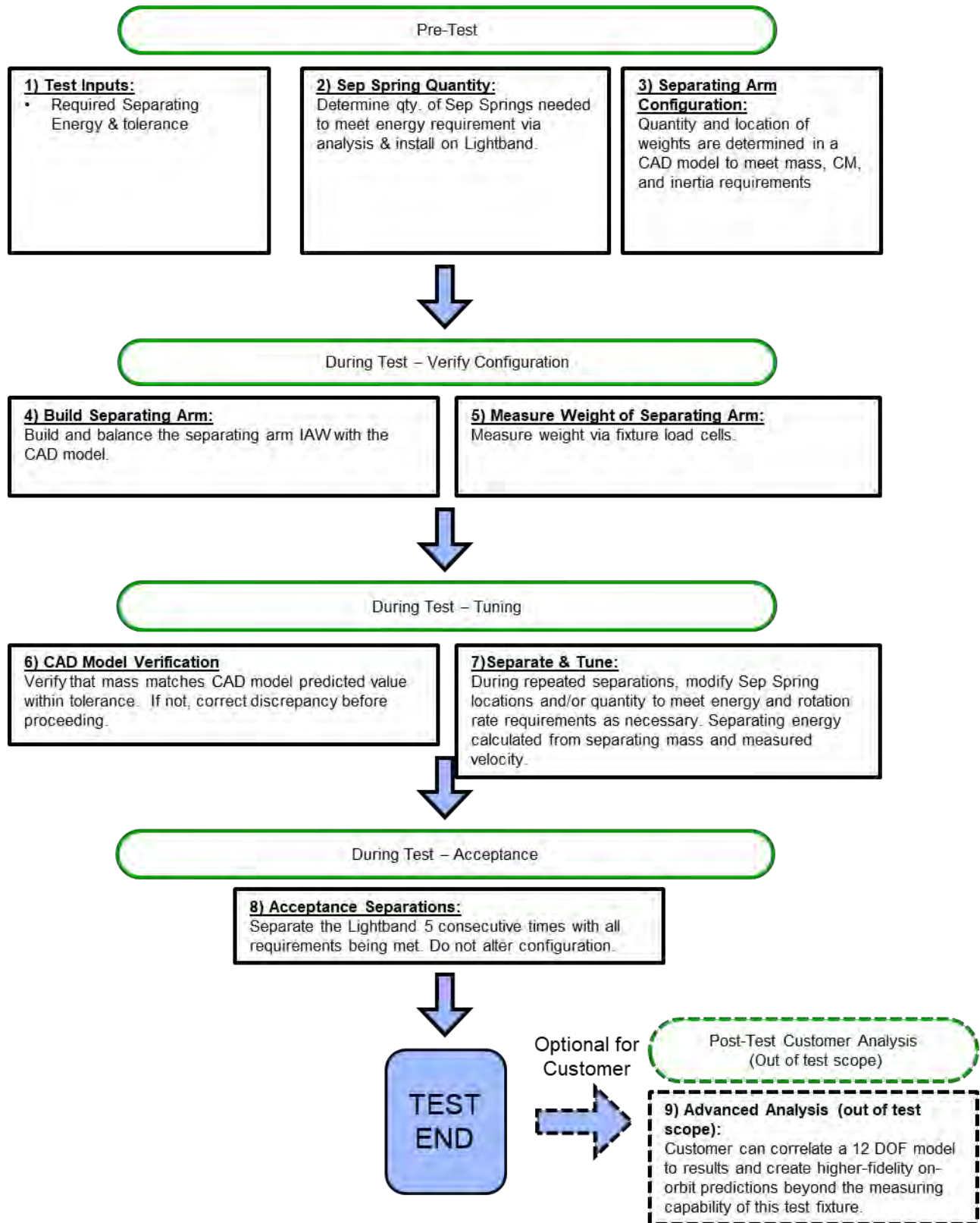

Figure 16-9: Nominal separation reliability test flow

16.2.2 Strength Test

Location: PSC or qualified vibration test facility

Objective: Verify strength of the MLB

Test Fixture: PSC Strength Test Fixture or software-controlled vibration table

Test Method: Quasi-static loading or sine burst (to be selected by PSC based on engineering judgement)

Test Description: During this test, the test item shall be exposed to quasi-static loading or sine burst loading that is intended to simulate in-flight acceleration forces in the set-for-flight configuration. Each combination of loads is known as a load case. In some sine burst tests, the loads shall be applied independently along each axis. Upon completion of all load cases, the test item will be separated and then formally inspected.

Test Levels: Lower limit shall be minimum customer load requirement. Upper limit shall be the maximum capability given in Table 5-1.

- a) Strength test fixture: The required load is held within required load limits for at least 60 seconds. Load is applied in approximately 20% increments.
- b) Sine Burst: minimum 5 cycles within required load limits

Number of Separations: One (1) following all load cases.

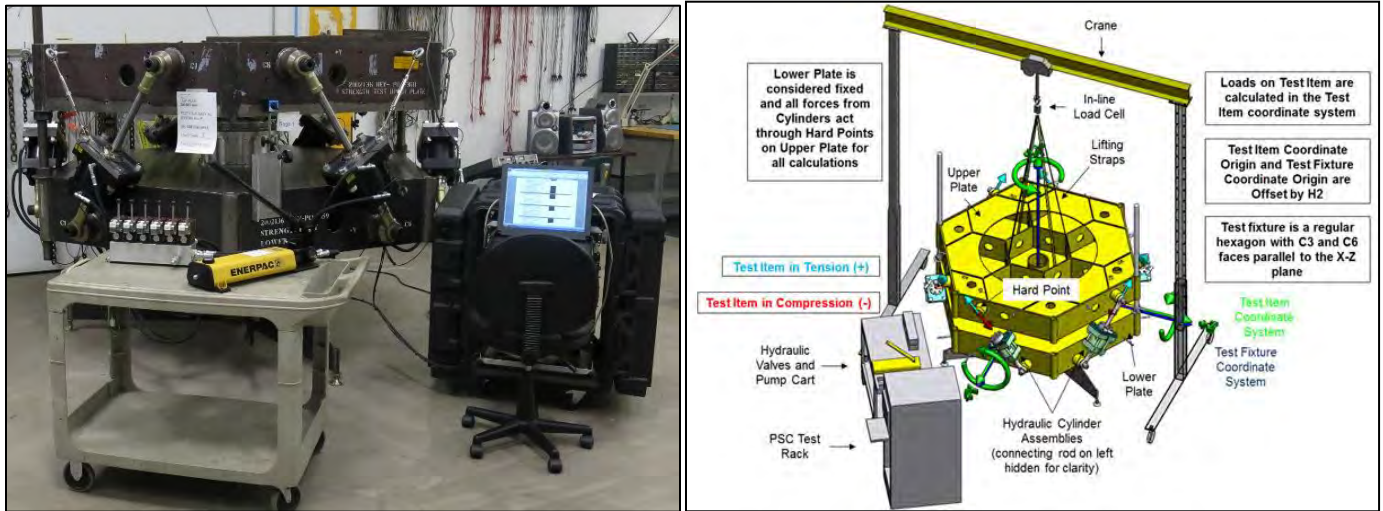

Figure 16-10: The PSC strength test fixture

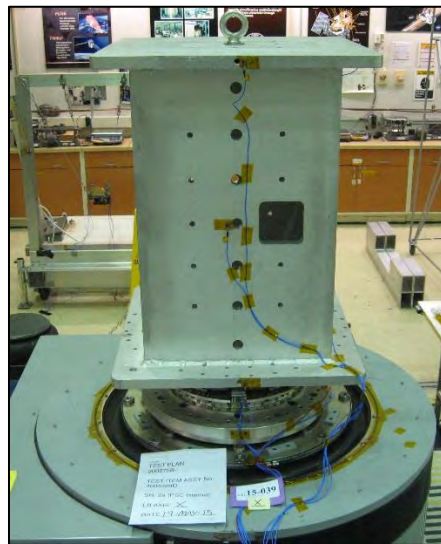

Figure 16-11: Sine burst strength test of a MLB15

Strength Testing

Source Document(s): PSC Document 2000785

Test Objective: Demonstrate that the test item operates nominally after quasi-static loading

Test Complete Criteria: 1. The required loads are applied to the test item.

2. The test item is inspected IAW PSC Document 2001066 "MkII MLB Inspection Report" upon completion of all load cases.

3. All attendees of the PSC-internal Test Complete Review (TCR) approve the test plan and results.

Notes: (1) In a separation, springs travel at least 0.7 inches, in an initiation, springs travel 0.0 inches.

(2) "-" is compression in test item.

(3) Peak load target is 102.5% to ensure that 100% requirement is reached.

Load Application		
	Load Case 1	Load Case 2
F _{XLB} [lbf] (2)	Derived by customer requirement and Lightband diameter.	Derived by customer requirement and Lightband diameter.
F _{YLB} [lbf]		
F _{ZLB} [lbf]		
M _{XLB} [in*lbf]		
M _{YLB} [in*lbf]		
M _{ZLB} [in*lbf]		
Peak Load Duration [s]	60	60
Max. Allowable Load [%]	105	105

Functional test following all load cases		
Operation (1)	Voltage [V]	Motor(s) Powered
Separation	28.0	Both

Pre-test Analysis		
Load Case	Max. X _{LB} Line Load [lb/bolt] (Axial)	Max. Y _{LB} or Z _{LB} Line Load [lb/bolt] (Shear)
1	Derived by customer requirement and Lightband diameter.	Derived by customer requirement and Lightband diameter.
2		
3		
4		
Allow able [lb/bolt]	1,880	774
Max Actual [lb/bolt]	Derived	Derived
Margin [-]	Derived	Derived
Margin = (Allowable/Max Actual) - 1		

Deflection Gage Placement		
Gage	Position	Orientation
1	+Y _{fixture} Axis	-Y _{fixture} Axis
2	+Z _{fixture} Axis	-X _{fixture} Axis
3	-Z _{fixture} Axis	-X _{fixture} Axis

Load Application (3)		
Step	Load Percentage [%]	Increment or Decrement ?
1	0	Increment
2	20	Increment
3	40	Increment
4	60	Increment
5	80	Increment
6	102.5	Increment
7	80	Decrement
8	60	Decrement
9	40	Decrement
10	20	Decrement
11	0	Decrement

Figure 16-12: Example of custom strength test requirements (performed as quasi-static loading)

17. Purchasing, Deliverables, & Schedule

17.1 Purchasing an MLB

Contact PSC directly to receive the most up-to-date MLB prices. The standard payment schedule is shown in Table 17-1.

Event	Payment [%]
After Kick-off Meeting	35
Build complete review (BCR) completion	45
Shipment	20

Table 17-1: Standard MLB schedule

17.2 Standard Delivery Schedule

Standard MLBs are typically delivered in 34 to 42 weeks ARO. Some MLBs can potentially be expedited at an additional cost.

17.3 Custom MLB Schedule

Whenever an MLB deviates from requirements defined in this document (e.g. requires custom features, additional testing, different procedures, or different compliance documents) it is a Custom MLB. See Section 6.2. Prospective users should be aware that the cost and schedule of custom MLBs is often substantially greater than the standard MLBs presented in this document. Table 17-2 outlines a typical custom MLB program.

Event	Description	Deliverables from PSC	Preferred Contract Type
Phase I	Complete specification of the customization	<ul style="list-style-type: none"> • Assembly drawings • All test procedures • Custom tooling, design, and drawings • Manufacturing and test schedule • Anomaly reporting 	Cost plus fixed fee or time and materials
Phase II	Build and test MLB(s) to Phase I	<ul style="list-style-type: none"> • MLB(s) • Test results 	Firm fixed price
Any change to Phase I	Any "to be determined" or any change in requirements that exceeds specifications in Phase I	Modifications for hardware, procedure, schedule, etc.	Cost plus fixed fee or time and materials

Table 17-2: Typical custom MLB program

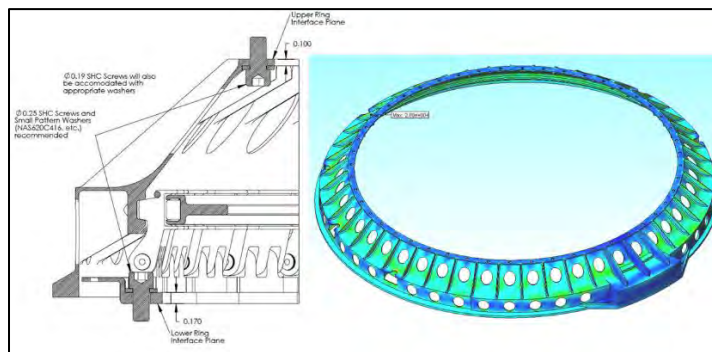

Figure 17-1: Custom work example - modified Upper Ring for an MLB31.600 Mk II used on the IBEX program

17.4 MLB Deliverables

The items included in the price of an MLB and delivered to the customer are:

1. The MLB(s)
2. Copies of all as-run test procedures and reports
3. Certificate(s) of conformance
4. Training on MLB operation (at PSC's facility)

Additional deliverables may be included in the case of custom MLBs.

17.5 MLB STEP Files

STEP files of simplified MLB assemblies are available to prospective users and customers for download. These models allow the generation of unique Separation Spring, Connector and Switch configuration. PSC reserves the right to move Separation Spring locations to satisfy rotation rate requirements when PSC completes separation reliability testing on flight MLBs. Users may request a STEP model at <https://www.rocketlabusa.com/space-systems/separation-systems/>.

Note the MLB STEP models do not show all components or their full extent of travel. Users shall not use simplified MLB STEP models to verify clearance. Instead, use the stayout zone CAD models available on the website for clearance verification.

17.6 Assembly Drawings

PDFs of assembly drawings can be made available to customers before delivery. Assembly drawings include bills of material. This item is subject to US Export Control regulation.

17.7 MLB Finite Element Models

PSC has test-verified finite element models (FEM) of MLBs available for customers. To accurately predict line loading through the MLB, customers should incorporate the FEM into their flight stack model. Contact PSC for further information. This item is subject to US Export Control regulation.

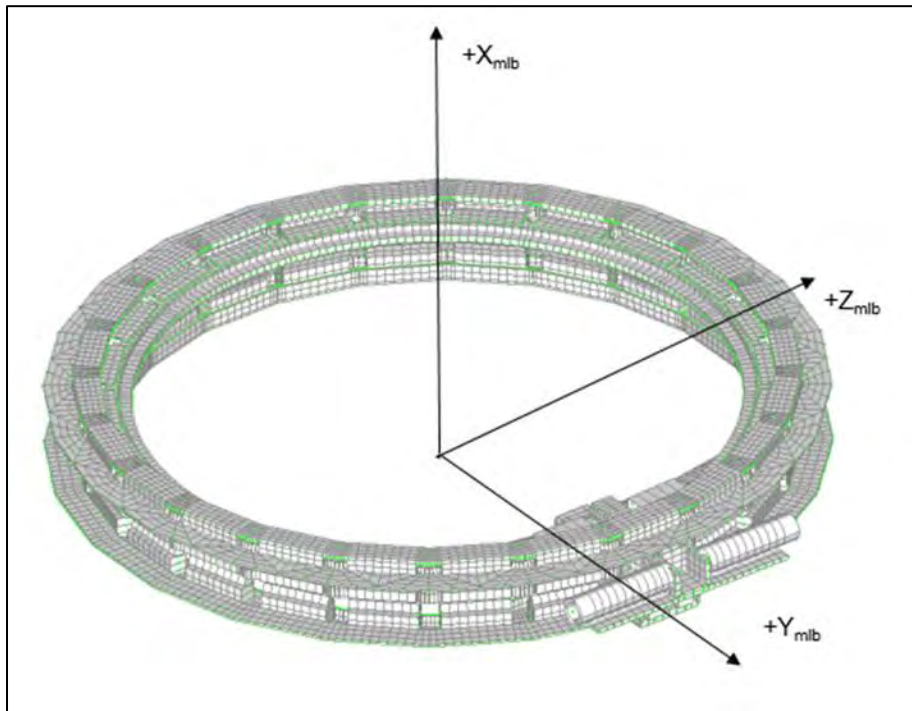

Figure 17-2: MLB 15.000 FEM

18. Manufacturing Process

Engineers at PSC design, assemble, and test MLBs. PSC is an AS 9100-compliant organization. All of the machining and fabrication is completed by vendors qualified to PSC's standards. PSC maintains documentation of all tasks associated with flight hardware procurement, storage, assembly, test, and shipment. All of these are enveloped by PSC's quality management program. Procurement, manufacturing, and stocking are controlled by inventory management software. MLBs and their subsystems are tracked and completely traceable using their purchase order, serial number, or lot number. Just like in testing at PSC, manufacturing is done in teams. Two trained PSC staff sign-off on steps in manufacturing procedures (one acts as the technician, the other as quality assurance) and execute a Build Complete Review (BCR) as the final step in the completion of the manufacturing procedures. PSC writes, executes and approves manufacturing procedures. PSC also takes any corrective action after required customer notification if anomalies arise. The customer-furnished wiring harness is not included in the manufacturing of an MLB.

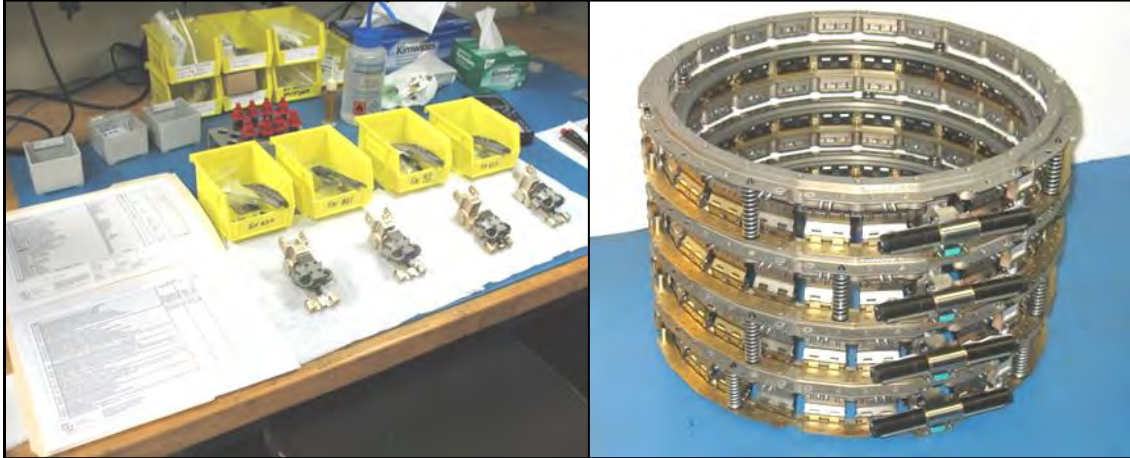

Figure 18-1: MLB assembly at PSC

19. Qualification Testing

Various diameters of MLBs have received qualification environmental testing on multiple occasions. Qualification tests of MLB diameters shown in Table 5-1 are generally not required and shall be considered custom work. This section is intended as a reference to present proven limits of the MLB during previous environmental qualification tests.

19.1 Random Vibration Qualification Test

Tested vibration parameters of a 15 inch diameter MLB are shown in Figure 19-1.

WARNING: These vibration levels should not be applied to the MLB when the MLB is supporting a substantial mass. The prescribed environment below is for the MLB alone. When the MLB is supporting a structure, engineers must determine how the vibration environment will generate line loading and how much of the MLB's fatigue life will be consumed.

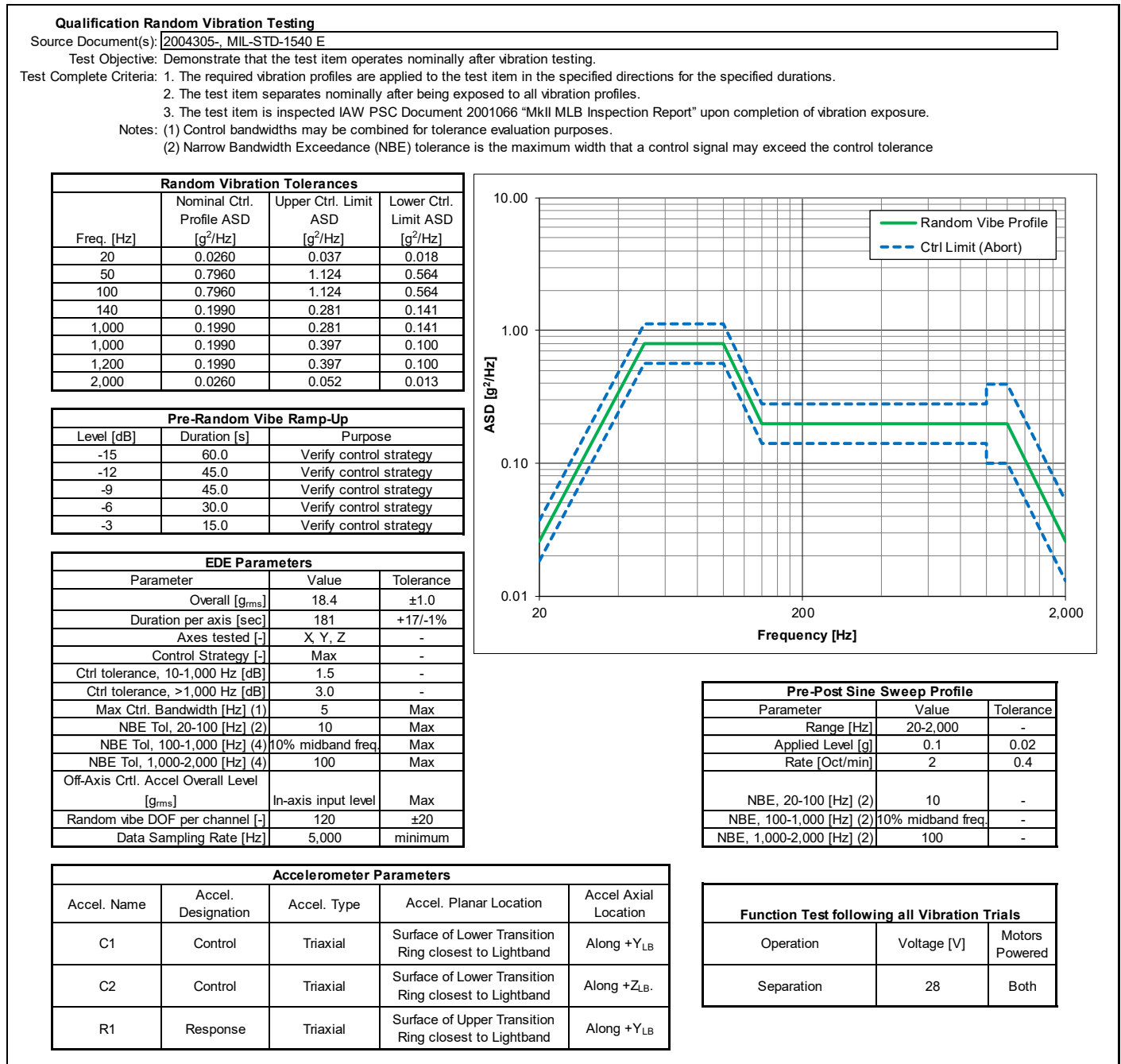

Figure 19-1: Previously-executed qualification random vibration test parameters

19.2 Thermal Vacuum Qualification Test

Tested thermal vacuum parameters of a 15 inch diameter MLB are shown in Figure 19-2.

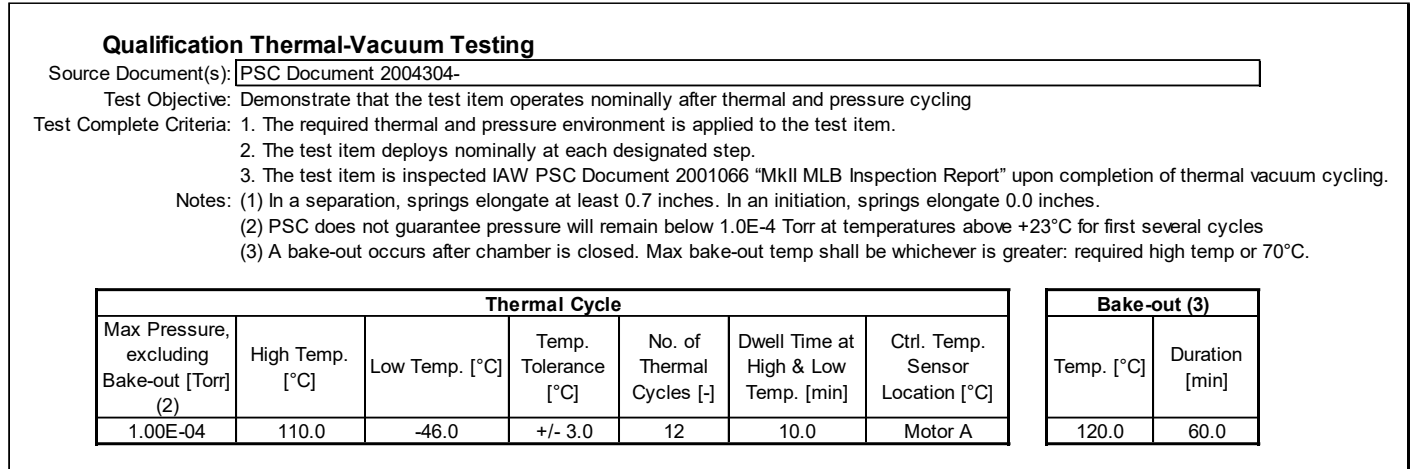

Figure 19-2: Previously-executed qualification thermal vacuum test parameters

19.3 Strength Qualification Test

Tested strength parameters of a 15 inch diameter MLB are shown in Figure 19-3.

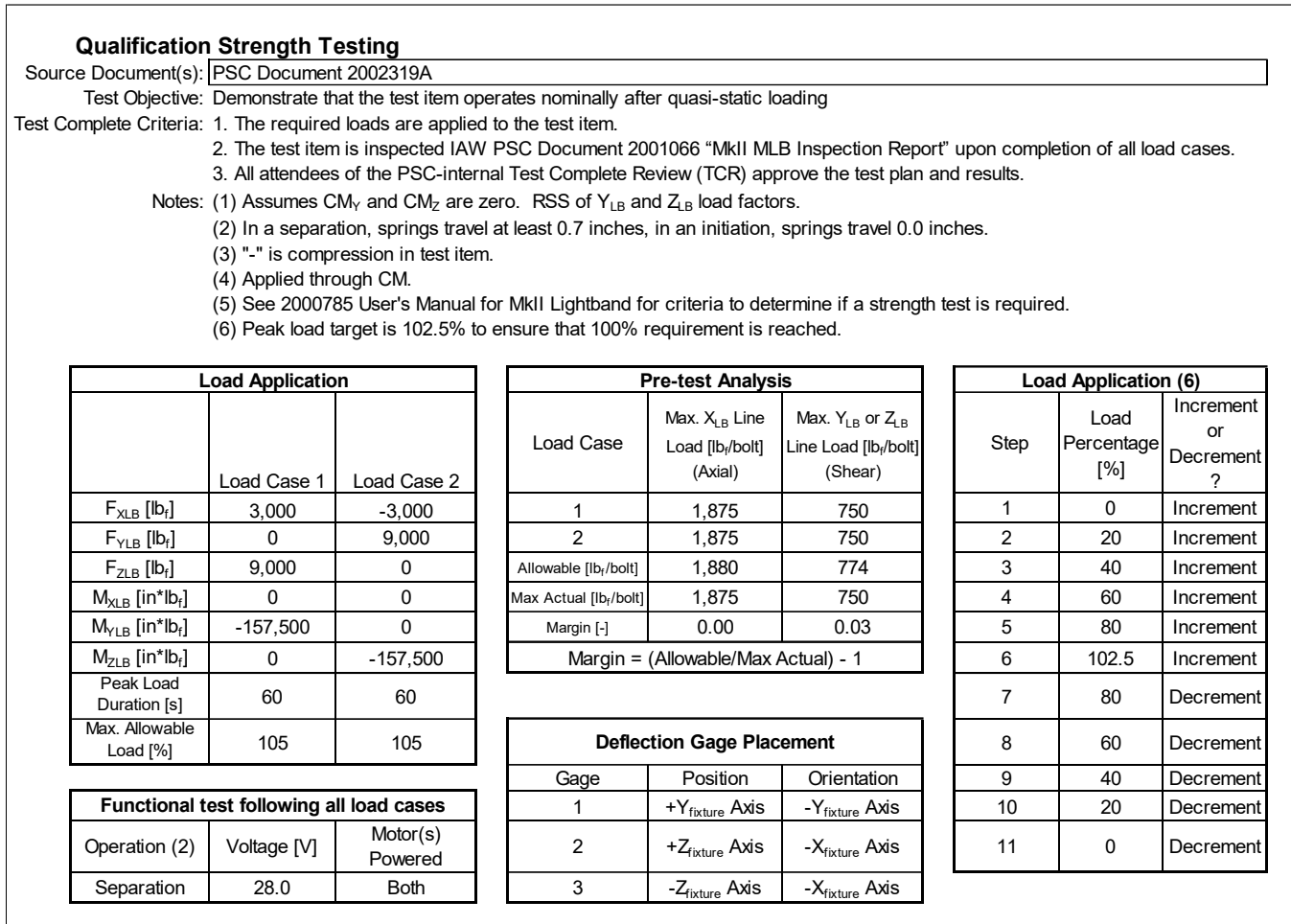

Figure 19-3: MLB15 qualification strength test parameters

Strength test requirements for the 8 inch diameter qualification MLB are shown in Figure 19-4.

Source Docs.:	PSC Document 2000785F MkII MLB User Manual			
Test Objective:	Demonstrate that the test item can withstand qualification level quasi-static loading.			
Test Complete	1. The required loads are applied to the test item.			
Criteria:	2. The test item separates nominally after being exposed to all load cases. 3. The test item is inspected IAW PSC Document 2001066 "MkII MLB Inspection Report" upon completion.			
Notes:	1) "-" is compression in test item. 2) Peak load may be increased at discretion of test director and chief engineer.			

Test Levels (1)				
Parameter	Load Case 1	Load Case 2	Load Case 3	Load Case 4
$F_{X_{LB}}$ [lbf]	11,280	22,560	-11,280	-22,560
$F_{Y_{LB}}$ [lbf]	0	0	0	0
$F_{Z_{LB}}$ [lbf]	0	0	0	0
$M_{X_{LB}}$ [in*lbf]	0	0	0	0
$M_{Y_{LB}}$ [in*lbf]	0	0	0	0
$M_{Z_{LB}}$ [in*lbf]	0	0	0	0
X_{LB} Line Load (Axial) [lb/bolt]	940	1,880	940	1,880
Y_{LB} or Z_{LB} Line Load (Shear) [lb/bolt]	0	0	0	0
Peak Load Tolerance [%] (2)	100 to 120	100 to 110	100 to 120	100 to 110
Peak Load Duration, min [s]	60	60	60	60

Gage Placement (5)	
Gage 1	X-axis displacement
Gage 2	X-axis displacement
Gage 3	Y or Z axis displacement

Functional test following all load cases		
Operation	Cmd. Voltage [V]	Motor(s) Powered
Separation	28.0	Both

Figure 19-4: MLB8 qualification strength test parameters

19.4 Shock Qualification Test

Tested applied shock parameters on a 15 inch diameter MLB are shown in Figure 19-5.

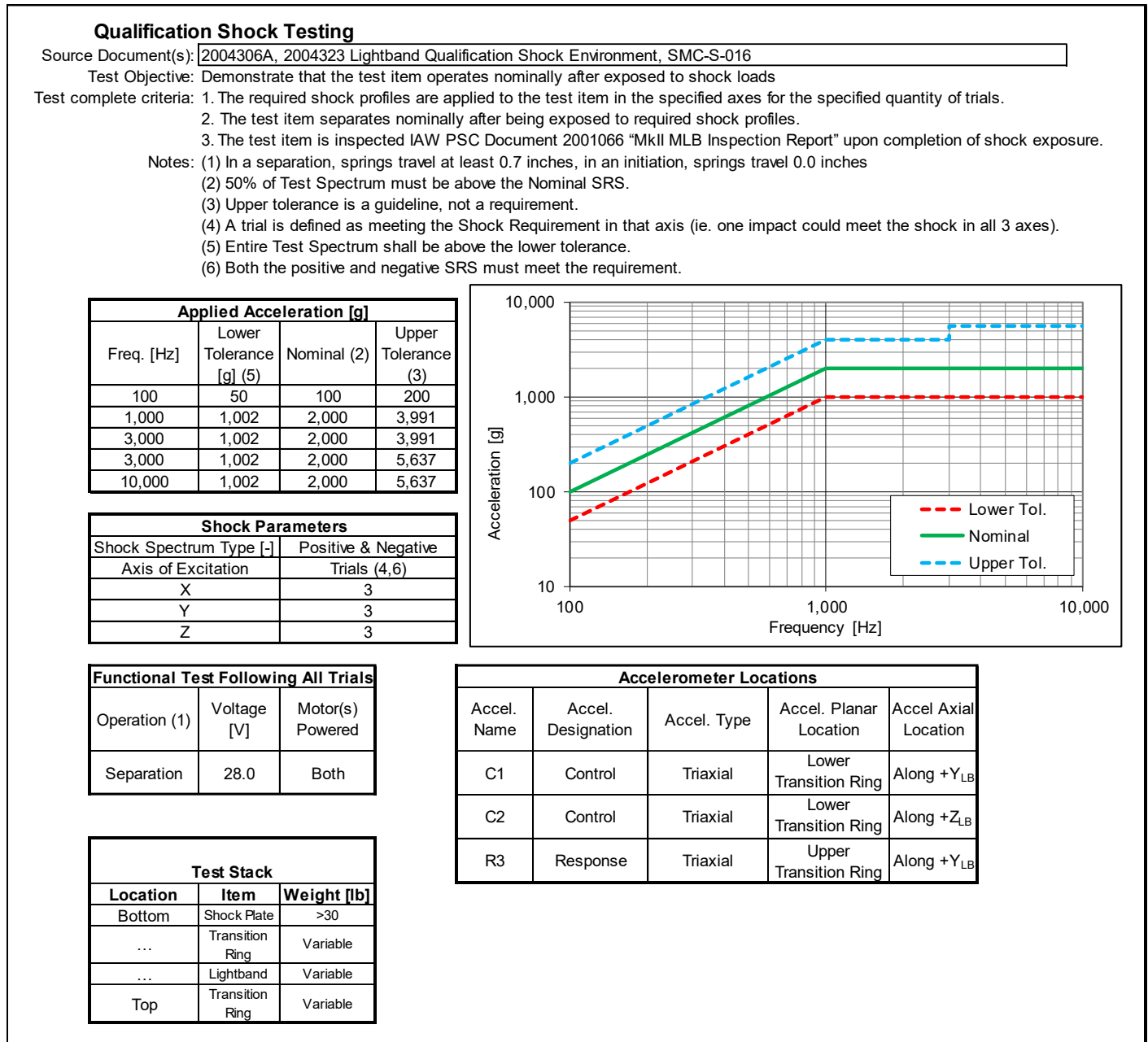

Figure 19-5: Previously-executed qualification shock test parameters

20. MLB Inspection

After assembly, each acceptance test, and before shipment, the MLB goes through a standardized inspection procedure defined in PSC Document *2001066 Mk II MLB Inspection Report*. The purpose of the inspection is to characterize the condition of the MLB in a consistent and quantifiable manner. Each subcomponent of the MLB is examined and measured where applicable. The actions of this process are performed by the Test Director and independently verified by another trained PSC staff who acts as quality assurance. Inspections can be performed at any time.

21. MLB Testing and Procedures Performed by Customer

Customers often complete some of these tests and procedures after receiving the MLB. Note: MLB training is required. See Section 23. Flight MLBs should not be used for mass-loaded vibration testing. If mass-loaded vibration testing is required by the launch provider a waiver should be requested given the MLB's qualification or an EDU MLB shall be used. Further, all test and flight environments shall be accurately predicted using a finite element model of the MLB and payload. During testing, the test results shall be continually compared to analytical predictions for sufficient agreement.

Test or procedure	Objective	Remarks and cautions
Receive MLB training from PSC	Learn how to operate MLB and uncover unexpected potential integration difficulties	Can be performed with a PSC training MLB or the customer's flight unit. Default location is PSC's facility.
Fit check to adjoining structures	Verify bolt patterns and clocking	Is the electrical wiring harness attached during this procedure?
System-level vibration test	Verify workmanship and modes	Will the MLB be overloaded at resonance? Are notching or force limiting methods employed?
Electrical initiation test	Verify the initiation circuit and power system from the launch vehicle will properly initiate the MLB. Verify adjoining vehicle will receive the proper signal upon separation.	Ensure MLB operation procedures are being followed by using the latest revision of PSC Document <i>2000781 MkII MLB Operating Procedure</i> .

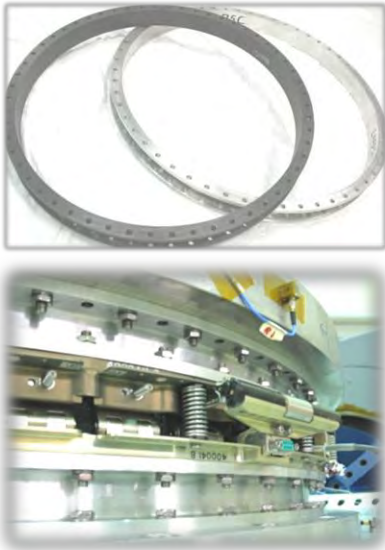

Table 21-1: Testing and other procedures



Figure 21-1: Electro-mechanical fit check and a separation test with an MLB

22. Ground Support Equipment (GSE)

For program planning, several pieces of GSE are listed below that have been useful to customers in the past. Generally, PSC neither supplies nor lends-out GSE.

Item	Description	Graphic
<p>Mass mock-ups with the MLB bolt pattern.</p>	<p>A structure that has the same mass and center of mass as the payload. Caution: structures such as these tend to exhibit low damping values and at resonance substantially increase response. Force limiting or notching of input may be required to prevent damage. Precise machining is required to meet flatness requirements.</p>	
<p>Transition Ring</p>	<p>Fastens to the Upper or Lower Ring. Useful to attenuate flatness issues of adjoining structures, allow access to fasteners to MLB and to allow a MLB to operate. The MLB must be attached to an adjoining structure or it will flex too much when stowing.</p>	
<p>Vibration Adapter Plate</p>	<p>The interface between an electro-dynamic exciter and the MLB or a Transition Ring.</p>	
<p>MLB Controller</p> <p>Components: oscilloscope, power supply, relay time, ammeter, & more</p>	<p>Used to stow, deploy, and set-for-flight the MLB. Requires a cable between the MLB and the controller with DB-9 connectors.</p>	



Item	Description	Graphic
<p>MLB Test Rack</p>	<p>PSC engineers use this in the field to automatically deploy, stow and set-for-flight the MLB for high value programs. Records each motor's current and voltage at 5,000 samples/second. Calculates power, energy, and duration. Weighs 130 lb.</p>	 <p>The graphic shows a black rugged test rack with a laptop on top. To the right is a screenshot of a software interface displaying a graph of Current (A) vs Time (Sec).</p>
<p>Crane Compliance Sling</p>	<p>Allows for axial compliance when mating the Upper and Lower Rings of the MLB</p>	 <p>The graphic shows a vertical assembly of three springs connected by a central hook and top rings.</p>
<p>Reduced head diameter fasteners</p>	<p>On the MLB 15.000-24 Lower Ring PSC uses 0.25-28 socket head cap screws with the head diameter reduced to 0.340 in. This eliminates the interference fit with the Leaves. PSC Document 4000845.</p>	 <p>The graphic shows two small socket head cap screws on the left and a larger threaded fastener with a reduced diameter section on the right.</p>

Table 22-1: Ground support equipment

23. MLB Training

MLB training at PSC's facility is included in the price of the MLB. It can be performed at another location at an additional cost. Operation of the MLB by any customer personnel is prohibited until they have received training. The training session lasts approximately 8 hours. Trained personnel are certified to operate their MLB(s) for 24 months after successfully completing training.

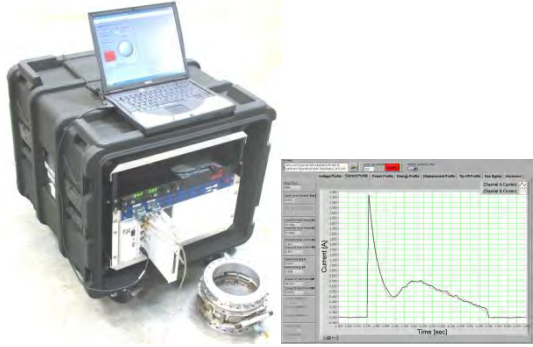
Training sessions are incredibly important and reduce mission risk. In addition to learning how to operate the MLB, customers will be able to discuss their expected integration scenario. PSC's trainers will help uncover potential unforeseen issues during integration and discuss all possible solutions. By having this discussion before customer operations and integration, customers will streamline all processes involving the MLB and prevent expensive program delays.

At a minimum, the following topics will be covered during the training session

- How the MLB works
- Best practices
- Warnings and warranty violation items
- Required materials
- Handling precautions
- Mechanical attachment procedure
- Stowing procedure
- Setting-for-flight procedure
- Deploying procedure
- Preparing the MLB for compression
- Removal from adjoining structure procedure
- Horizontal integration procedure (if applicable)
- Lightband Compression Tool procedure (if applicable)
- Mission assurance verifications
- Customized discussion of mission integration details to improve efficiency
- Any other topics desired by the customer

24. Packing, Shipping and Unpacking Methods

PSC Document 2000827 MkII MLB Pack-Unpack Procedure defines the methods to pack and unpack the MLB from its shipping container.

Graphic	Description
	<p>The MLB is shipped in the deployed state with the Motor Bracket Assembly in the stowed position to constrain motion during shipping. Stiffening elements are installed to hold the Upper and Lower Ring separated.</p>
	<p>The MLB is prepared for shipment. Typically, each MLB is shipped in a custom-designed protective case dedicated for that particular unit. The case is reusable.</p>
	<p>The MLB is bagged and sealed.</p>
	<p>Composite foam shapes encapsulate the MLB inside its case.</p>
	<p>The case is sealed with the MLB and documentation inside. The contents are indicated on the outside of the case.</p>
	<p>The default shipping service is FedEx - Standard Overnight. Shipping weight and size varies by MLB diameter.</p>
	<p>Customer receives the MLB and unpacks IAW with PSC Document 2000827 MkII MLB Pack-Unpack Procedure</p>

Table 24-1: Packing, shipping, and unpacking method

25. References

Reference Publications
Lightband As Enabling Technology AIAA-RS2 2004-7005
Multi-Payload Integration Lessons Learned from Space Test Program Mission 26, Proceedings from the 25 th Small Sat Conference
SSC06-IX-7 Lessons Learned Developing Separation Systems For Small Satellites
Automating Separation System Testing, Proceedings of the 36 th Aerospace Mechanisms Symposium, Glenn Research Center, May 15-17, 2002
Lessons Learned Designing A Spherical Satellite Release Mechanism, 39 th Aerospace Mechanisms Symposium, Huntsville Alabama, May 2008
Requirements For Threaded Fastening Systems In Spaceflight Hardware, NASA-STD-5020, March 12 2012

Table 25-1: List of Reference Publications

26. Warranty

The MLB warranty is defined in *PSC Document 1001015 Warranty MLB*.

27. Acknowledgements

PSC would like to thank Mike Froelich of Ball Aerospace and Greg Rahal of Northop Grumman Innovation Systems for their many constructive suggestions and patience with several of the anomalies PSC encountered as the MLB attained its present maturity.

28. Glossary

- **ARO:** After receiving order
- **Bench-top testing:** A separation test of the MLB on a bench top. Rate and velocity information are not recovered.
- **Build Complete Review (BCR):** Verify product assembly is complete (and hence ready for test). This includes bench-top separation.
- **CM:** Center of mass
- **CTE:** Coefficient of thermal expansion
- **CVCM:** Collected volatile condensable material
- **Electro dynamic exciter (EDE):** A machine used to apply vibratory loading.
- **EMF:** Electromotive Force
- **End Item Data Package (EIDP):** As run test plans, production log and certification.
- **Engineering Development Unit (EDU):** An MLB designated for use on the ground to allow engineers to use flight like hardware. EDU are not exposed to standard testing, they only receive several bench-top separation tests prior to delivery
- **FEA:** Finite element analysis
- **Flight (FLT) Unit:** An MLB designated for use as a hardware that will fly into space. Flight units are exposed to standard acceptance testing prior to delivery
- **FMEA:** Failure modes and effects analysis
- **GSE:** Ground support equipment
- **IAW:** In accordance with
- **Lightband Compression Tool (LCT):** Assemblies used to safely mate the Upper and Lower Rings together.
- **MBA:** Motor Bracket Assembly
- **MLB:** Motorized Lightband
- **MOI:** Moment of inertia
- **NBE:** Narrow bandwidth exceedance
- **Nominal Operation:** Separation of the MLB at $23 \pm 10^{\circ}\text{C}$ with both motors at $28 \pm 4\text{ V}$.
- **Product Build Specification (PBS):** A summary document of requirements for testing and subsystem configuration (springs, switches, connectors).
- **SCC:** Stress corrosion cracking
- **Set-for-flight (SFF):** Moving the ball nut from the Stow End Plate to the Deploy End Plate. This relatively low power operation significantly decreases the time to initiate by reducing the distance the ball nut needs to travel to initiate.
- **SOW:** Statement of work
- **SRS:** Shock response spectrum
- **Stow:** To join the MLB by operating the motors until both Stow Limit Switches open a circuit
- **Test Readiness Review (TRR):** Verify test plans meet PBS
- **Time to initiate:** Power on until either Deploy Limit Switch first opens a circuit
- **Time to deploy (or separate):** Power on until a loop-back in a Separation Connector opens a circuit. This corresponds to about 0.130 inch of travel in the X_{LB} direction.
- **Test Complete Review (TCR):** A meeting that is held to review the results of the test. The outcome of the meeting is to deem the test a success or failure. At a minimum, two PSC engineers and either the Chief Engineer or President must attend.
- **TML:** Total mass loss
- **WRT:** With respect to